

11

Diagnostik  
Diagnostic  
Diagnostic  
Diagnóstico



كحلkopfspiegel  
Laryngeal mirrors

Kehlkopfspiegel  
Laryngeal mirrors  
Miroirs laryngiens  
Espejos laríngeos

11



11.8	Fig. 000	=	6 mmØ	11.28
11.9	Fig. 00	=	8 mmØ	11.29
11.10	Fig. 0	=	10 mmØ	11.30
11.11	Fig. 1	=	12 mmØ	11.31
11.12	Fig. 2	=	14 mmØ	11.32
11.13	Fig. 3	=	16 mmØ	11.33
11.14	Fig. 4	=	18 mmØ	11.34
11.15	Fig. 5	=	20 mmØ	11.35
11.16	Fig. 6	=	22 mmØ	11.36
11.17	Fig. 7	=	24 mmØ	11.37
11.18	Fig. 8	=	26 mmØ	11.38
11.19	Fig. 9	=	28 mmØ	11.39
11.20	Fig. 10	=	30 mmØ	11.40

11.25  
10,0 cm/4"  
Metallgriff für Kehlkopfspiegel  
Metal handle for laryngeal mirrors  
Manche pour miroirs laryngiens  
Mango metálico para espejos laríngeos

Percussions h ammer  
Percussion hammers  
Marteaux-percuteurs  
Martillos de percusi n

11



**Babinsky**

11.45  
22 cm/8 $\frac{3}{4}$ "

**Babinsky**

11.45-01  
Gummi allein  
Rubber only  
Gomme seul  
Goma suelta



**Taylor**

11.46  
20 cm/8"



**Berliner**

11.47  
20 cm/8"



**Traube**

11.48  
17 cm/6 $\frac{3}{4}$ "



**Troemner**

11.49  
24 cm/9 $\frac{1}{2}$ "

Percussions h ammer  
Percussion hammers  
Marteaux-percuteurs  
Martillos de percusi n

11

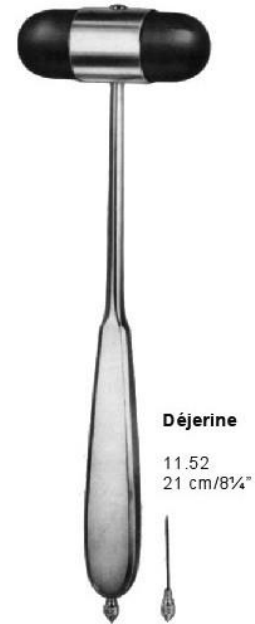
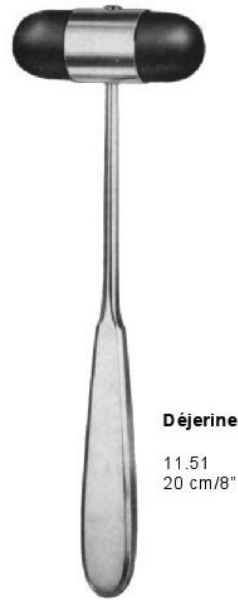
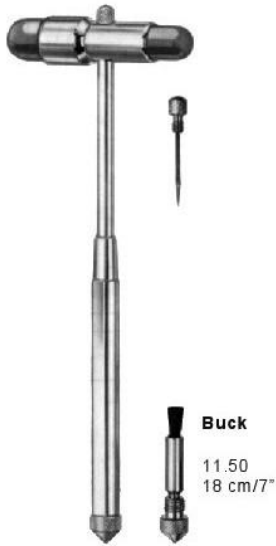

ohne Nadel  
without needle  
sans aiguille  
sin aguja

mit Nadel  
with needle  
avec aiguille  
con aguja



Prüf- und meßinstrumente  
 Examination and measuring instruments  
 Instruments pour examiner et mesurer  
 Instrumento para exámenes y medidas

11

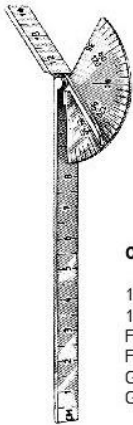

**Caroll**

11.56  
 14,0 cm/5½"  
 Finger-Goniometer  
 Finger-Goniometer  
 Goniomètre  
 Goniómetro

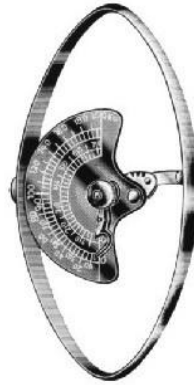

**Collin**

11.57  
 12,5 cm/5"  
 Dynamometer, für Kinder  
 Dynamometer, for children  
 Dynamomètre, pour enfants  
 Dinamómetro, para niños

11.58  
 12,5 cm/5"  
 Dynamometer, für Erwachsene  
 Dynamometer, for adults  
 Dynamomètre, pour adultes  
 Dinamómetro, para adultos



**Moeltgen**

11.59  
 24,0 cm/9½"  
 Winkelmesser für die Gliedmaßen  
 Goniometer (Flexometer) for extremities  
 Goniomètre pour les membres  
 Goniómetro para miembros



**Wartenberg**

11.60  
 19,0 cm/7½"  
 Nervrädchen  
 Neurological Pinwheel  
 Roue neurologique  
 Instrumento para examen neurológico

Prüf- und Meßinstrumente  
 Examination and measuring instruments  
 Instruments pour examiner et mesurer  
 Instrumento para exámenes y medidas

11

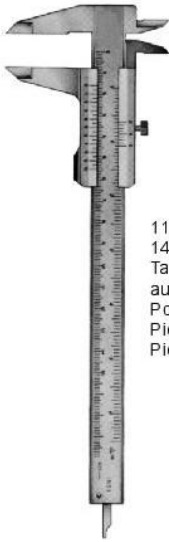

11.61  
 14,0 cm/5½"  
 Taschen-Meßschieber  
 aus nichtrostendem Stahl  
 Pocket Slide Caliper, of stainless steel  
 Pied à coulisse de poche, en acier inoxydable  
 Pie de rey de bolsillo, de acero inoxidable

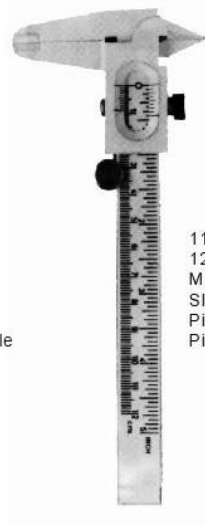

11.62  
 12,0 cm/5"  
 Meßschieber aus Kunststoff  
 Slide Caliper of synthetic material  
 Pied à coulisse, en matière synthétique  
 Pie de rey, en materia sintética



11.64  
 1,5 m  
 Bandmaß in Metallkapsel  
 aus Wachstuch/Leinen  
 Tape Measure in metal case  
 of oil cloth  
 Metre à ruban dans une boîte de métal  
 en toile cirée  
 Cinta métrica en cápsula metálica  
 de tela encerada



Metall-aMeßstab mit Millimetereinteilung  
 Metal Rule graduated in millimeters and inches  
 Règle en métal divisé en centimètres et pouces  
 Regla métrica de metal graduada en milímetros y pulgadas

- 11.66 15,0 cm/6"
- 11.67 20,0 cm/8"
- 11.68 30,0 cm/12"
- 11.69 50,0 cm/20"



11.70 15,0 cm/6"

11.65  
 2,0 m  
 aus Stahl  
 of steel  
 en acier  
 de acero

Stethoskope  
Stethoscopes  
Stéthoscopes  
Estetoscopios

11

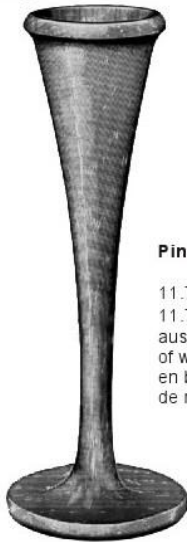

**Pinard**

11.71 30,0 cm/12"  
11.72 18,0 cm/7"  
aus Holz  
of wood  
en bois  
de madera



**Pinard**

11.73 15,0 cm/6"  
aus Aluminium  
of aluminium  
en aluminium  
de aluminio

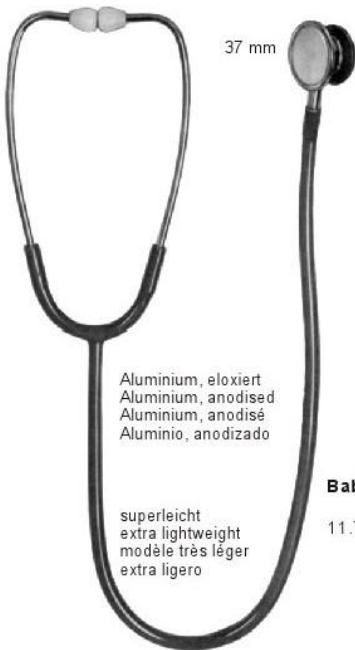

37 mm

Aluminium, eloxiert  
Aluminium, anodised  
Aluminium, anodisé  
Aluminio, anodizado

**Baby-Duplex**

superleicht  
extra lightweight  
modèle très léger  
extra ligero

11.75

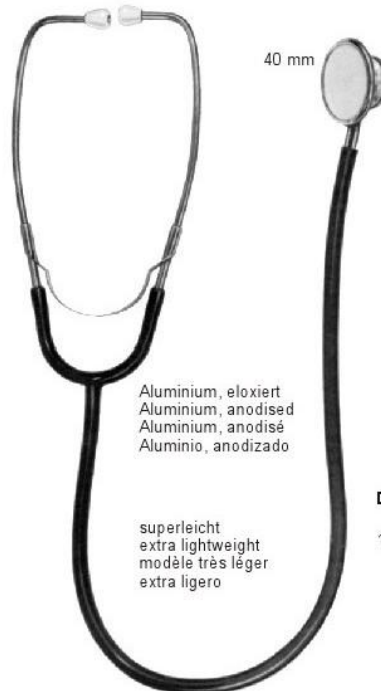

40 mm

Aluminium, eloxiert  
Aluminium, anodised  
Aluminium, anodisé  
Aluminio, anodizado

**Duplex**

superleicht  
extra lightweight  
modèle très léger  
extra ligero

11.76

Stethoskope  
Stethoscopes  
Stéthoscopes  
Estetoscopios

11



47 mm

**Anestophon**

11.77



**Rirap**

11.78

Drei verschiedene austauschbare Trichteransätze  
Three additional interchangeable bell-type pieces  
Trois pièces supplémentaires interchangeables  
Tres diferentes piezas adicionales intercambiables  
en forma de embudo



aus rostfreiem Stahl  
stainless steel  
en acier inoxydable  
de acero inoxidable

**Cardiophon**

11.79



Blutdruckmeßgeräte  
Blood pressure manometers  
Tensiomètres  
Manómetros para la presión de la sangre

11



#### Diplomat Presameter

11.80  
Quecksilbergerät  
Mercury apparatus  
Appareil de mercure  
Tensiómetro de mercurio

mit Hakenmanschette  
with hook cuff  
avec manchette à crochets  
con brazaletes a ganchos

11.81  
mit Velcromanschette  
with velcro cuff  
avec manchette velcro  
con brazaletes velcro



#### Empire

11.82  
Quecksilbergerät  
Mercury apparatus  
Appareil de mercure  
Tensiómetro de mercurio

mit Hakenmanschette  
with hook cuff  
avec manchette à crochets  
con brazaletes a ganchos

11.83  
mit Velcromanschette  
with velcro cuff  
avec manchette velcro  
con brazaletes velcro

Blutdruckmeßgeräte  
Blood pressure manometers  
Tensiomètres  
Manómetros para la presión de la sangre

11



#### Precisa

11.84  
Einhandmodell  
One hand model  
Modèle à main  
Modelo a mano

mit Velcromanschette  
with velcro cuff  
avec manchette velcro  
con brazaletes velcro

#### Minimus III

11.85  
Einhandmodell  
One hand model  
Modèle à main  
Modelo a mano

mit Hakenmanschette  
with hook cuff  
avec manchette à crochets  
con brazaletes a ganchos

11.86  
mit Velcromanschette  
with velcro cuff  
avec manchette velcro  
con brazaletes velcro



Stirnlampen  
Head lamps  
Eclaireurs frontaux  
Lámparas frontales

11



11.119  
Stirmband aus Plastik  
Head band of plastic  
Bandeau de plastique  
Cinta de plástico

11.122  
Ersatzspiegel, 100 mm Ø  
Mirror only, 100 mm Ø  
Miroir seul, 100 mm Ø  
Espejo suelto, 100 mm Ø

**Clar**  
Stirnlampe  
Head Lamp  
Eclaireur frontal  
Lámpara frontal

11.118  
mit Stirmband aus Plastik, 100 mm Ø  
with head band of plastic, 100 mm Ø  
avec bandeau de plastique, 100 mm de Ø  
con cinta de plástico, 100 mm de Ø

11.121  
Stirmband aus Celluloid  
Head band of celluloid  
Bandeau de celluloid  
Cinta de celuloide

11.123  
Ersatz-Birnchen, 6 V  
Spare bulb, 6 V  
Lampe de rechange, 6 V  
Bombillas de repuesto, 6 V

11.120  
mit Stirmband aus Celluloid, 100 mm Ø  
with head band of celluloid, 100 mm Ø  
avec bandeau de celluloid, 100 mm de Ø  
con cinta de celuloide, 100 mm de Ø



**Clar**  
Stirnlampe  
Head Lamp  
Eclaireur frontal  
Lámpara frontal

11.124  
mit Stirmband aus Celluloid  
with head band of celluloid  
avec bandeau de celluloid  
con cinta de celuloide

11.125  
Stirmband aus Celluloid  
Head band of celluloid  
Bandeau de celluloid  
Cinta de celuloide

11.126  
Ersatzspiegel, 100 mm Ø  
Mirror only, 100 mm Ø  
Miroir seul, 100 mm Ø  
Espejo suelto, 100 mm Ø



11.127  
Ersatz-Birnchen, 6 V  
Spare bulb, 6 V  
Lampe de rechange, 6 V  
Bombillas de repuesto, 6 V

Tonometer  
Tonometer  
Tonomètre  
Tonómetro

11



**Schioetz**

Tonometer, Spez. 5  
Tonometer, Spec. 5  
Tonomètre, Spécif. 5  
Tonómetro, Spec. 5

11.130  
gerade Skala  
straight scale  
cadre droit  
escala recta

11.131  
schräge Skala  
inclined scale  
cadre courbe  
escala inclinada

11.132  
Eichgebühr  
rate for gauging  
droits pour étalonnage  
precio para aforo



Instrumentarium zur hystero salpingographie  
Instrumentation for hystero-halpingography  
Instrumentation pour hystéro-salpingographie  
Instrumental para histero-salpingografia

11



**Schultze**

11.135  
20,0 cm/8"  
Salpingograph, komplett  
Salpingograph, complete  
Salpingographe, complet  
Salpingografo, completo

Komprimeter  
Comprimeter  
Appareil compressif complet  
Aparato de compresi3n

11



11.136  
Komprimeter  
Comprimeter  
Appareil compressif complet  
Aparato de compresi3n



Ohrspekula  
Ear specula  
Spéculums auriculaires  
Espéculos auriculares

11



Fig. 1  
11.151  
6 mm Ø



Fig. 2  
11.152  
7,5 mm Ø



Fig. 3  
11.153  
8,2 mm Ø



Fig. 4  
11.154  
10 mm Ø

### Bruenings

11.150  
Ohrspekula, komplett  
Ear Specula, complete  
Spéculum auriculaire, complet  
Espéculo auricular, completo

11.156  
Gummiball mit Schlauch, allein  
Rubber Bulb and tube, only  
Poire soufflante et tube, seule  
Insuflador con tubo, solo

11.157  
Holzetui, allein  
Wooden Case, only  
Boîte en bois, seule  
Estuche de madera, solo



11.155  
Kopfstück, allein  
Head piece, only  
Pièce de tête, seule  
Pieza de cabeza, solo



### Hartmann

Ohrspekula  
Ear Specula  
Spéculum auriculaire  
Espéculo auricular



Fig. 0  
11.160  
3,0 mm Ø



Fig. 1  
11.161  
4,0 mm Ø



Fig. 2  
11.162  
5,0 mm Ø



Fig. 3  
11.163  
6,0 mm Ø



Fig. 4  
11.164  
7,5 mm Ø

Stimmgabeln  
Tuning forks  
Diapasons  
Diapasónes

11



**Hartmann**  
c 128  
11.180-00



**Hartmann**  
c 1 256  
11.180-01



**Hartmann**  
c 2 512  
11.180-02



**Hartmann**  
c 3 1024  
11.180-03



**Hartmann**  
c 4 2048  
11.180-04



**Hartmann**  
c 5 4096  
11.180-05

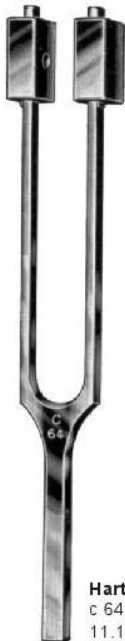

**Hartmann**  
c 64  
11.180-06



**Hartmann**  
c 128  
11.180-07



**Hartmann**  
c 1 256  
11.180-08

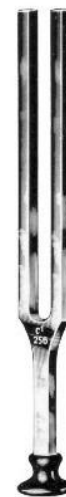

**Hartmann**  
mit Fuß, with foot  
avec pied, con pie  
c 1 256  
11.180-09



Stimmgabeln  
Tuning forks  
Diapasons  
Diapasónes

11

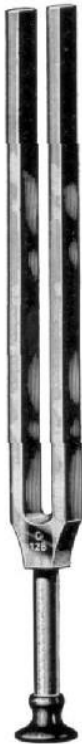

**Lucae**  
c 128  
11.181-00



**Lucae**  
c 256  
11.181-01



**Lucae**  
c 512  
11.181-02



**Lucae**  
c 1024  
11.181-03



**Lucae**  
c 2048  
11.181-04



**Lucae**  
c 4096  
11.181-05



**Lucae**  
c 128  
11.181-06

Stimmgabeln  
Tuning forks  
Diapasons  
Diapasónes

11



**French**  
c<sub>2</sub> 16  
Doppel-Contra  
Double-contra  
Double-contra  
Doble-contra

11.182-01



**French**  
c<sub>1</sub> 32  
Contra  
Contra  
Contra  
Contra

11.182-02



**Rydel-Seiffer**  
C 64 / c 128  
mit Dämpfern = C 64 / ohne Dämpfer = c 128  
with clamps = C 64 / without clamps = c 128  
avec curseurs = C 64 / sans curseurs = c 128  
con sordinas = C 64 / sin sordinas = c 128

11.183-01

Stimmgabeln  
Tuning forks  
Diapasos  
Diapasónes

11



Stimmgabel für neurologische Untersuchungen, mit Reflexhammer, Nadelrad, Pinsel und Nadel

Tuning fork for neurological examinations, with percussion hammer, pinwheel, brush, and needle

Diapason pour examens neurologiques, avec marteaux-percuteurs, roue aux épingles, brosse et aiguille

Diapasón para exámenes neurológicos, con martillo percusor, rueda con espigas, cepillo y aguja

11.184-01



**Koenig**  
A 109  
verschiebbar bis g  
variable up to g  
variable jusqu' à g  
variable hasta g

11.185-01



a<sup>1</sup> 440  
11.186-01



A 218  
11.186-02

Stimmgabeln  
Tuning forks  
Diapasons  
Diapasónes

11

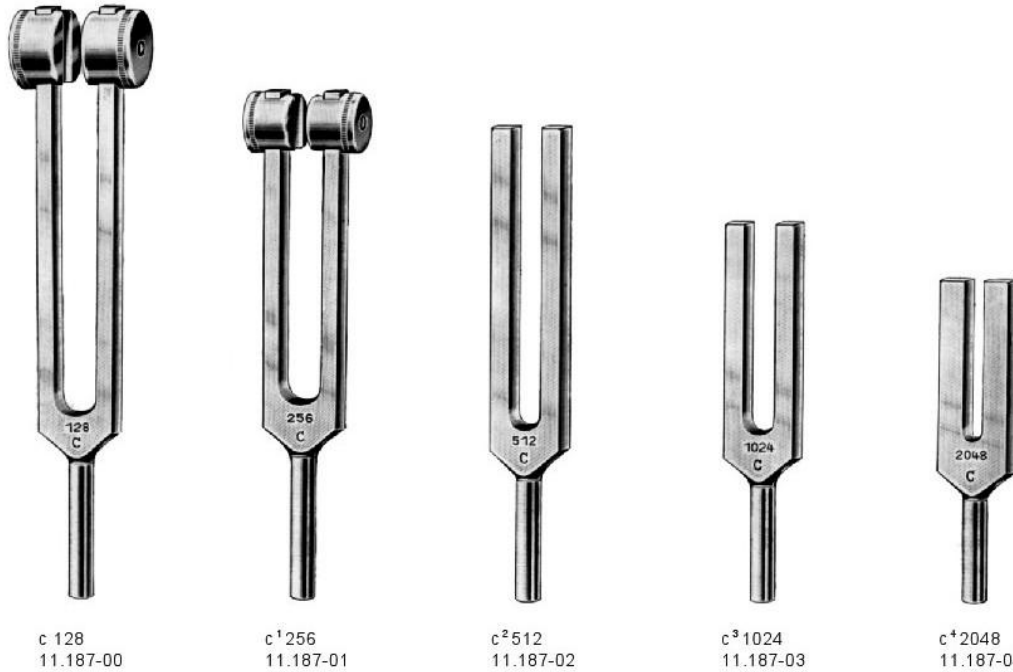

Stimmgabeln aus Spezial Aluminium-Magnesium-Legierung für medizinische Zwecke z. B. für Gehörprüfungen (Luft- und Knochenleitung), für Sensibilitätsprüfungen und andere diagnostische Zwecke.

Tuning forks made from special aluminium-magnesium-alloy, for medical purposes, such as examination of hearing (air and bone conduction), for sensibility examinations, and other diagnostic purposes.

Diapasons faits d'un alliage spécial d'aluminium et de magnésium, à des fins médicales, telles que l'examen de l'ouïe (conduite de l'air et os) et l'examen de la sensibilité et tout autre diagnostique.

Diapasón de una aleación especial al aluminio y magnesio, destinado a fines médicos por ejemplo, reconocimiento del oído (conduito del aire y huesos), reconocimiento de la sensibilidad y otros fines diagnósticos.

Stimmgabeln  
Tuning forks  
Diapasons  
Diapasónes

11



11.188-00  
Satz zu 5 Spezial Aluminium-Magnesium-Legierung Stimmgabeln im Etui  
Set of 5 special aluminium-magnesium-alloy tuning forks in a case  
Jeu de 5 diapasons, alliage spécial aluminium/magnésium dans un étui  
Set de 5 diapasones de una aleación especial de aluminio y magnesio en estuche  
(11.187-00, 11.187-01, 11.187-02, 11.187-03, 11.187-04)



11.189-05  
Satz zu 5 Hartmann Stimmgabeln im Etui  
Set of 5 Hartmann tuning forks in a case  
Jeu de 5 Hartmann diapasons dans un étui  
Set de 5 Hartmann diapasones en estuche  
(11.180-02, 11.180-03, 11.180-04, 11.180-07, 11.180-08)

Stimmgabeln  
Tuning forks  
Diapasons  
Diapasónes

11



11.189-06  
Satz zu 6 Hartmann Stimmgabeln im Etui  
Set of 6 Hartmann tuning forks in a case  
Jeu de 6 Hartmann diapasons dans un étui  
Set de 6 Hartmann diapasones en estuche  
(11.180-02, 11.180-03, 11.180-04,  
11.180-05, 11.180-07, 11.180-08)



11.189-08  
Satz zu 8 Hartmann Stimmgabeln im Etui  
Set of 8 Hartmann tuning forks in a case  
Jeu de 8 Hartmann diapasons dans un étui  
Set de 8 Hartmann diapasones en estuche  
(11.180-02, 11.180-03, 11.180-04, 11.180-05,  
11.180-06, 11.180-07, 11.180-08, 11.182-02)