

Impfen und Punktion
Vaccination and Puncture
Vaccination et ponction
Vacunación y punción

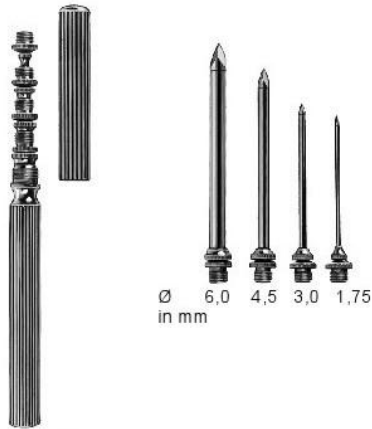



Universal

24.2603
mit Satz 3-teilig (4,5/3,0/1,75mm)
with set of 3 pieces(4,5/3,0/1,75mm)
avec jeu de 3 pièces(4,5/3,0/1,75mm)
con juego de 3 piezas(4,5/3,0/1,75mm)

24.2604
mit Satz 4-teilig
with set of 4 pieces
avec jeu de 4 pièces
con juego de 4 piezas



Universal

24.2606
mit Satz 3-teilig (4,5/3,0/1,75mm)
with set of 3 pieces(4,5/3,0/1,75mm)
avec jeu de 3 pièces(4,5/3,0/1,75mm)
con juego de 3 piezas(4,5/3,0/1,75mm)

24.2607
mit Satz 4-teilig
with set of 4 pieces
avec jeu de 4 pièces
con juego de 4 piezas

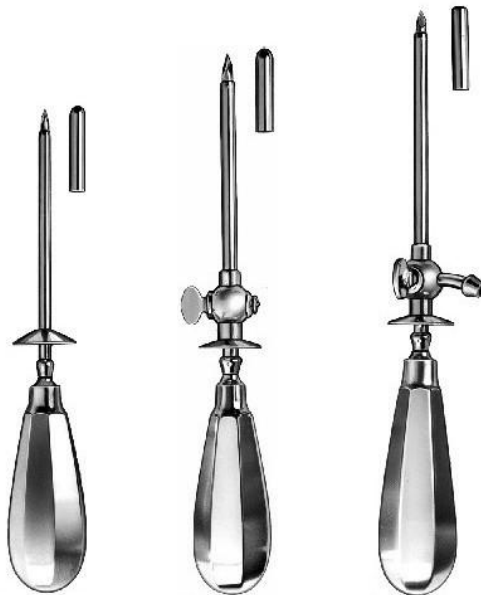

Ø mm	Standard 11,0 cm/4 1/4"	Standard 12,0 cm/4 3/4"	Standard 12,0 cm/4 3/4"
3,0	24.2610	24.2620	24.2630
3,5	24.2611	24.2621	24.2631
4,0	24.2612	24.2622	24.2632
4,5	24.2613	24.2623	24.2633
5,0	24.2614	24.2624	24.2634
5,5	24.2615	24.2625	24.2635
6,0	24.2616	24.2626	24.2636



Nelson
21,0 cm/8½"

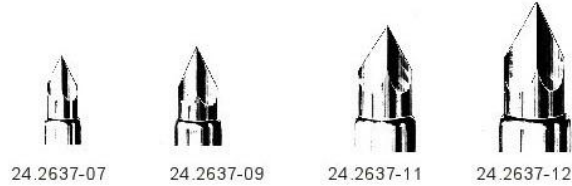

	24.2637-07	24.2637-09	24.2637-11	24.2637-12
Ø außen, Ø outside Ø à l'extérieur, Ø al exterior	7,5 mm	9,5 mm	11,0 mm	12,5 mm
Ø innen, Ø inside Ø à l'intérieur, Ø al interior	6,0 mm	8,0 mm	9,5 mm	11,0 mm

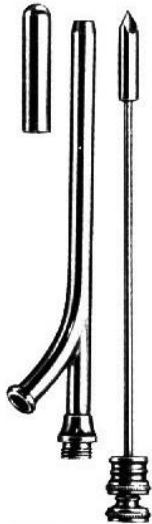

Ochsner
14,5 cm/5½"

	Charr.	mm
24.2640-10	10	3,0
24.2640-12	12	4,0
24.2640-14	14	4,5
24.2640-16	16	5,5
24.2640-18	18	6,0
24.2640-20	20	6,5
24.2640-22	22	7,5
24.2640-24	24	8,0
24.2640-26	26	8,5
24.2640-28	28	9,0

Ø außen
Ø outside
Ø à l'extérieur
Ø al exterior

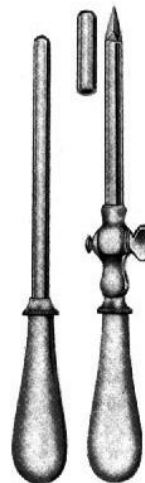

Buelau
24,0 cm/9½"

24.2641-08	8,0 mm	6,5 mm
24.2641-10	10,0 mm	8,5 mm

Ø außen Ø innen
Ø outside Ø inside
Ø à l'extérieur Ø à l'intérieur
Ø al exterior Ø al interior





Landau
24.2642-01



Landau
24.2642-02



Péan
24.2644



Lichtwitz
24.2651



Lichtwitz
24.2652



Pierce
24.2655 3,0 mmØ
24.2656 4,0 mmØ
24.2657 5,0 mmØ



Krause

24.2660



Coakley

24.2661



Führungsnadel, gerade
Guide Needle, straight
Aiguille d'introduction, droite
Aguja de guía, recta

Charr.	
8	24.2662-08
10	24.2662-10
12	24.2662-12
14	24.2662-14
16	24.2662-16
18	24.2662-18



Führungsnadel, gebogen
Guide Needle, curved
Aiguille d'introduction, courbe
Aguja de guía, curva

Charr.	
8	24.2663-08
10	24.2663-10
12	24.2663-12
14	24.2663-14
16	24.2663-16
18	24.2663-18



Führungsnadel, mit Lanzettenspitze
Guide Needle, with lancet point
Aiguille d'introduction, à pointe lancéolaire
Aguja de guía, con punta lanceolar

Charr.	
8	24.2664-08
10	24.2664-10
12	24.2664-12
14	24.2664-14
16	24.2664-16
18	24.2664-18



Adson
21,0 cm/8½"

	Charr.	Ø mm
24.2668-12	12	4,0
24.2668-15	15	5,0



Wullstein
14,0 cm/5½"

0,4 mmØ 0,6 mmØ 0,8 mmØ

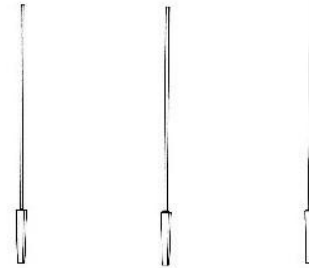

24.2669-04 24.2669-06 24.2669-08

24.2669-01
Mikro-Absaugrohr allein, mit Luer-Bohrung
Micro suction tube only, with Luer perforation
Micro tube d'aspiration seule, avec perforation Luer
Micro tubo de aspiración suelto, con perforación de Luer

24.2669-00

Satz komplett 24.2669-01 - 24.2669-08
Set complete 24.2669-01 - 24.2669-08
Jeu complet 24.2669-01 - 24.2669-08
Juego completo 24.2669-01 - 24.2669-08



Frazier
18,0 cm/7"

Arbeitslänge
Working length
Longueur utile
Largo útil
12,5 cm/5"

Charr.	
6	24.2670-06
7	24.2670-07
8	24.2670-08
9	24.2670-09
10	24.2670-10
11	24.2670-11
12	24.2670-12
15	24.2670-15



Frazier
18,0 cm/7"

	Charr.	Ø mm
24.2671-09	9	3,0
24.2671-15	15	5,0



Fergusson
18,0 cm/7"

	Charr.	Ø mm
24.2672-00	12	4,0



Fergusson
18,0 cm/7"

	Charr.	Ø mm
24.2672-06	6	2,0
24.2672-07	7	2,3
24.2672-08	8	2,5
24.2672-09	9	3,0
24.2672-10	10	3,3
24.2672-11	11	3,5
24.2672-12	12	4,0
24.2672-15	15	5,0



Plester
19,5 cm/7½"

	Charr.	Ø mm
24.2673-05	5	1,5
24.2673-06	6	2,0
24.2673-07	7	2,3
24.2673-08	8	2,5
24.2673-09	9	3,0
24.2673-10	10	3,5



Punktionskanüle
Puncture Cannula
Canule à ponction
Cánula de punción

Klima-Rosegger
1,80 x 35 mm

24.2674

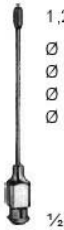

1,2 mm
Ø innen
Ø inside
Ø à l'intérieur
Ø al interior

Mock

24.2675-03 3,0 cm/1¼"
24.2675-06 6,0 cm/2½"



Biopsiekanüle
Biopsy Needle
Aiguille à biopsie
Aguja para biopsía

24.2676-01	1,00 x 35 mm
24.2676-02	1,00 x 70 mm
24.2676-03	1,20 x 70 mm
24.2676-04	1,20 x 100 mm
24.2676-05	1,40 x 70 mm
24.2676-06	1,40 x 100 mm
24.2676-07	1,60 x 70 mm
24.2676-08	1,80 x 100 mm

Menghini



Biopsiekanüle
Biopsy Needle
Aiguille à biopsie
Aguja para biopsía

24.2677-14	1,40 x 168 mm
24.2677-18	1,80 x 168 mm

Menghini



24.2678-01	2,00 x 80 mm
24.2678-02	2,00 x 100 mm
24.2678-03	2,00 x 120 mm

Verres

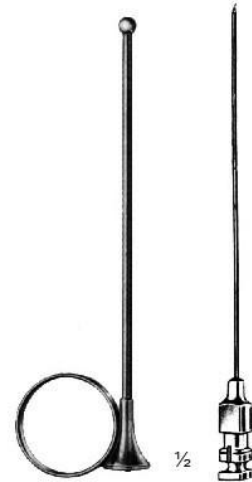

Iowa
14,0 cm/5½"

24.2679-00

Luer Lock
0,90 x 150 mm

24.2679-01



24.2680A

Saugkopf allein
 Aspiration part only
 Part d'aspiration seule
 Parte de aspiración suelta

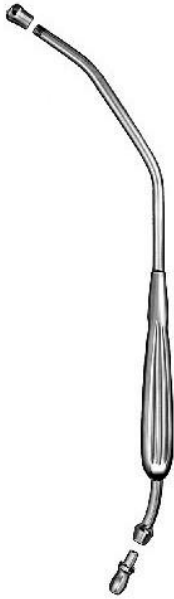

Yankauer

24.2680



10 mmØ
 (Charr./Fr. 30)

Poole
 22,0 cm/8¾"

24.2681



8 mmØ
 (Charr./Fr. 24)

Poole
 22,0 cm/8¾"

24.2682



De Bakay
 27,5 cm/10¾"

24.2683



Magill

Magill-Baby



24.2689

15,0 cm/6"
für Kleinkinder
pediatric size
pour bébés
para párvulos



24.2690

20,0 cm/8"
für Kinder
for children
pour enfants
para niños

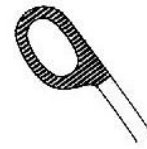

24.2691

25,0 cm/10"
für Erwachsene
for adults
pour adultes
para adultos



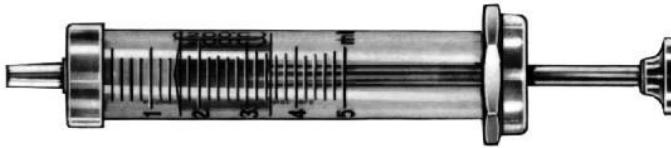

Luer

24.2692-01	1 ml
24.2692-02	2 ml
24.2692-05	5 ml
24.2692-10	10 ml
24.2692-20	20 ml
24.2692-50	50 ml

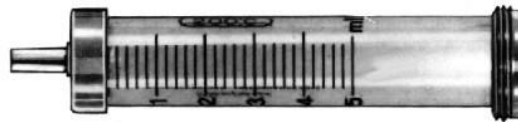

Luer

Zylinder	24.2693-01	1 ml
Barrels	24.2693-02	2 ml
Cylindre	24.2693-05	5 ml
Cilindro	24.2693-10	10 ml
	24.2693-20	20 ml
	24.2693-50	50 ml

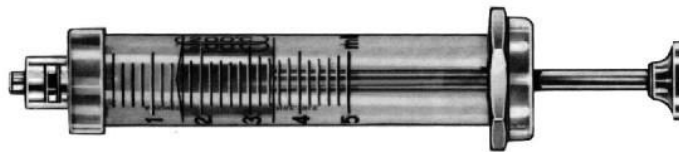

Luer Lock

24.2694-01	1 ml
24.2694-02	2 ml
24.2694-05	5 ml
24.2694-10	10 ml
24.2694-20	20 ml
24.2694-50	50 ml

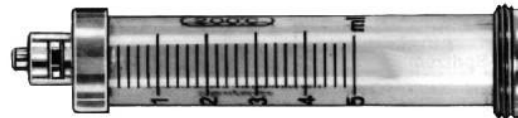

Luer Lock

Zylinder	24.2695-01	1 ml
Barrels	24.2695-02	2 ml
Cylindre	24.2695-05	5 ml
Cilindro	24.2695-10	10 ml
	24.2695-20	20 ml
	24.2695-50	50 ml



Spritze mit Luer-Lock Ansatz (mit 3 Ringen)
Syringe with Luer-Lock joint (with 3 rings)
Seringue avec arrêt Luer-Lock (avec 3 anneaux)
Jeringa con cierre Luer-Lock (con 3 anillos)

24.2696-02	2 ml
24.2696-05	5 ml
24.2696-10	10 ml



Zylinder	24.2697-02	2 ml
Barrels	24.2697-05	5 ml
Cylindre	24.2697-10	10 ml
Cilindro		

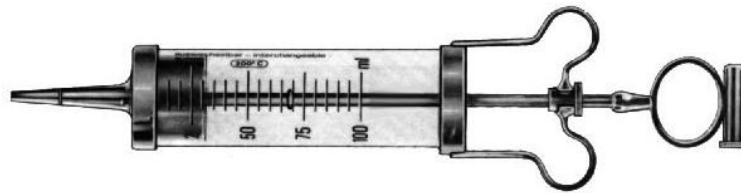

Janet

24.2698-05	50 ml
24.2698-07	75 ml
24.2698-10	100 ml
24.2698-15	150 ml
24.2698-20	200 ml
24.2698-25	250 ml

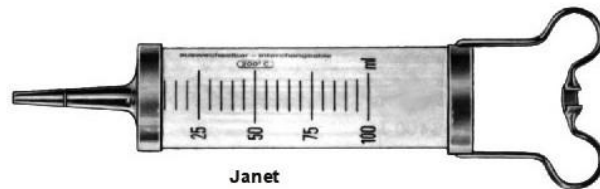

Janet

Zylinder	24.2699-05	50 ml
Barrels	24.2699-07	75 ml
Cylindre	24.2699-10	100 ml
Cilindro	24.2699-15	150 ml
	24.2699-20	200 ml
	24.2699-25	250 ml