

Wundhaken, Wundsperrer
Retractors
Ecarteurs
Separadores

26



Wundhaken
Retractors
Ecarteurs
Separadores



16,0 cm/6½"

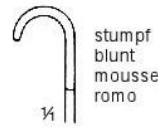
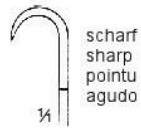

16,0 cm/6½"
flexibel
flexible
flexible
flexible

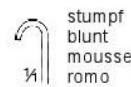

Wundhaken
Retractors
Ecarteurs
Separadores

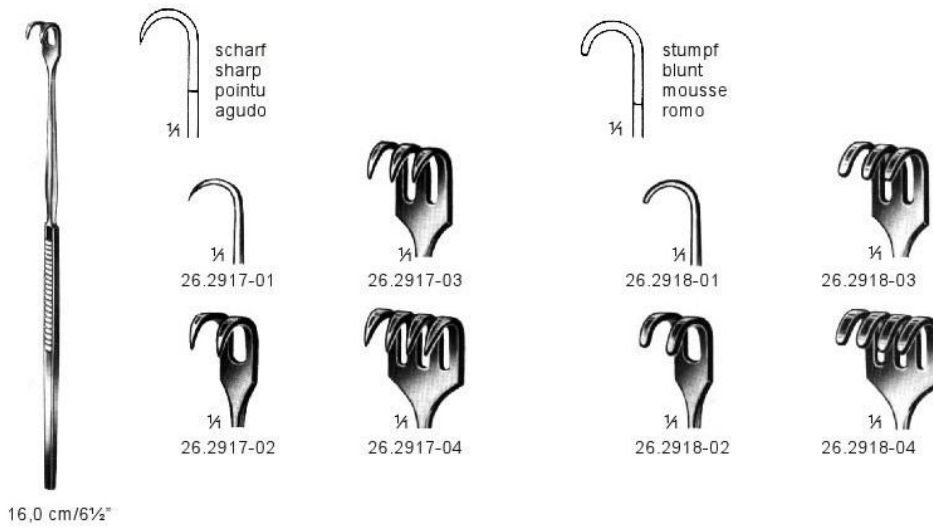

26

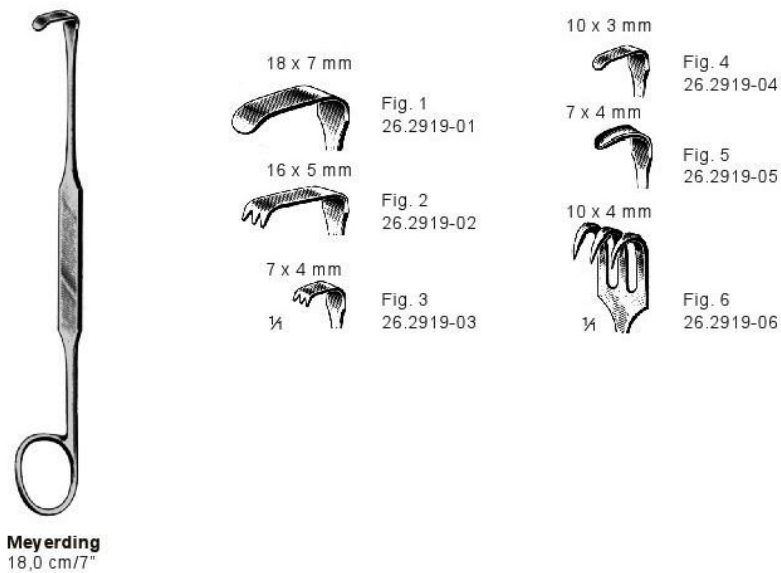

Wundhaken
Retractors
Ecarteurs
Separadores

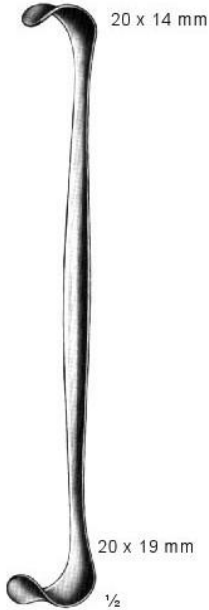

26.2922
20,0 cm/8"



Crile
26.2923
11,0 cm/4 1/4"



Klapp
17,5 cm/7"

Sehnenscheidenhaken
Tendon Sheath Retractors
Ecarteurs pour la gaine
Separadores para tendones



26.2924-01

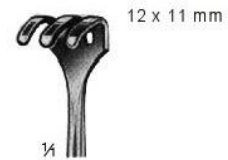

26.2924-02

26



Mini-Langenbeck
16,0 cm/6 1/2"



26.2925-10



26.2925-20



26.2925-17



26.2925-22

Wundhaken
Retractors
Ecarteurs
Separadores

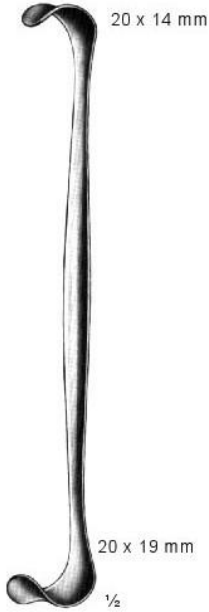

26.2922
20,0 cm/8"



Crile

26.2923
11,0 cm/4 1/4"



Klapp

17,5 cm/7"

Sehnenscheidenhaken
Tendon Sheath Retractors
Ecarteurs pour la gaine
Separadores para tendones



26.2924-01

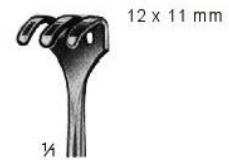

26.2924-02

26



Mini-Langenbeck
16,0 cm/6 1/2"



26.2925-10

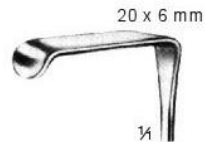

26.2925-20



26.2925-17

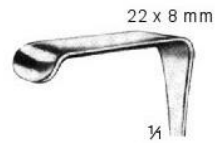

26.2925-22

Wundhaken
Retractors
Ecarteurs
Separadores

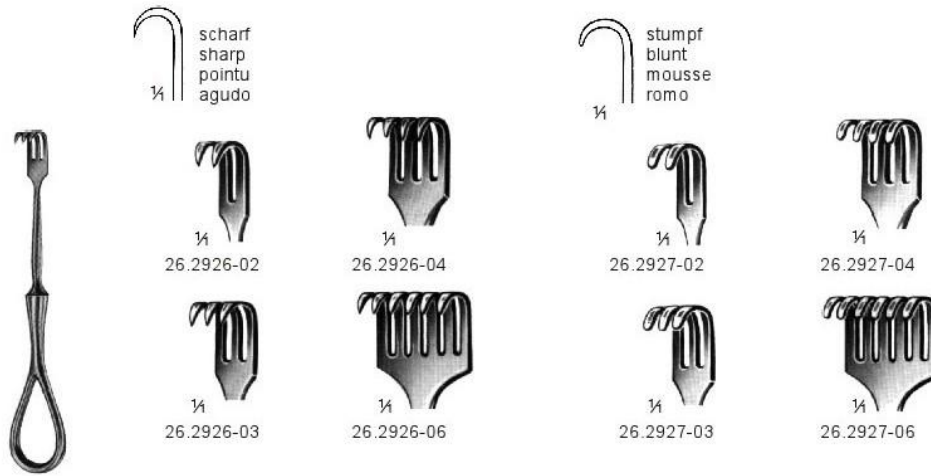

Volkman
11,5 cm/4½"



Strandell-Stille

26.2930-01
19,0 cm/7½"

Strandell-Stille

26.2930-02
19,0 cm/7½"

Cushing

26.2931
20,0 cm/8"

Dekompressionshaken
Decompression hook
Ecarteur de décompression
Separador para descompresión

Wundhaken
Retractors
Ecarteurs
Separadores



Volkmann
23,0 cm/9"



26.3001

scharf
sharp
pointu
agudo



26.3011

stumpf
blunt
mousse
romo



26.3002



26.3004



26.3012



26.3014



26.3003



26.3006



26.3013



26.3016

26



Volkmann
26.3021
21,5 cm/8½"

scharf
sharp
pointu
agudo



26.3022



26.3024

stumpf
blunt
mousse
romo



26.3032



26.3034



26.3023



26.3026



26.3033



26.3036



Volkmann
26.3031
21,5 cm/8½"

Wundhaken
Retractors
Ecarteurs
Separadores



scharf
sharp
pointu
agudo

Volkmann
26.3040
21,5 cm/8½"



stumpf
blunt
mousse
romo

Volkmann
26.3041
21,5 cm/8½"



scharf
sharp
pointu
agudo

26.3043
24,5 cm/10"



Kocher
22.0 cm/8½"

scharf
sharp
pointu
agudo



26.3051



26.3052



26.3053



26.3054



26.3056

26

stumpf
blunt
mousse
romo



26.3061



26.3062



26.3063



26.3064

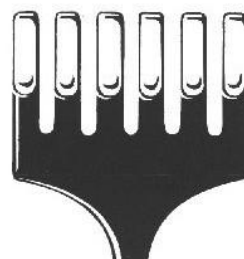

26.3066

Wundhaken
Retractors
Ecarteurs
Separadores



Koerte
23,5 cm/9 1/4"

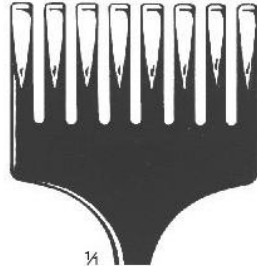

scharf
sharp
pointu
agudo

1/4
26.3067

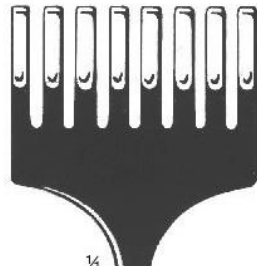

stumpf
blunt
mousse
romo

1/4
26.3068



36 x 60 mm

36 x 30 mm



1/2
26.3069-03

26.3069-04

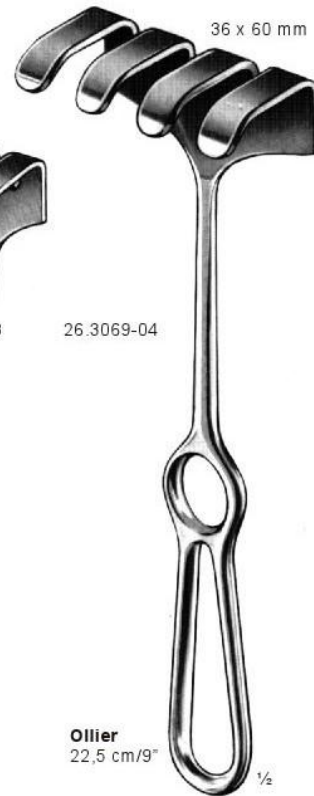

Ollier
22,5 cm/9"

1/2

33 x 20 mm



Wassmund

26.3070-20
20,5 cm/8"

26

Wundhaken
Retractors
Ecarteurs
Separadores



1/2
Israel
25,0 cm/10"

40 x 40 mm



1/2
26.3074-04

45 x 50 mm



1/2
26.3074-05

50 x 60 mm



1/2
26.3074-06

70 x 70 mm



1/2
26.3074-07

Wundhaken
Retractors
Ecarteurs
Separadores



Hüftgelenkhaken
Retractors
Ecarteurs
Separadores

1/2

Langenbeck
21,0 cm/8 1/4"

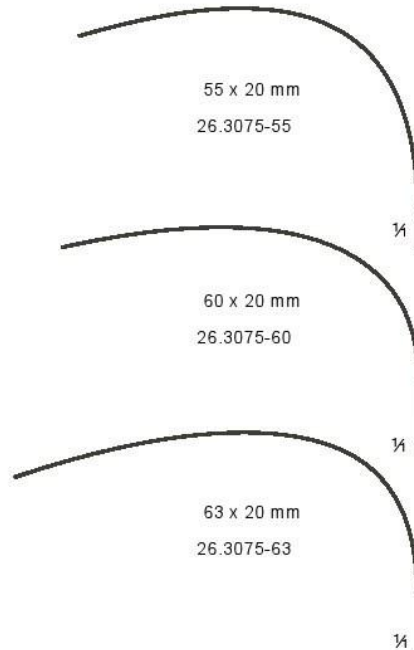

26



1/2

Langenbeck
21,0 cm/8 1/4"

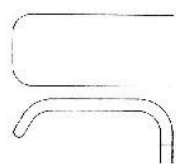

Kocher
21,5 cm/8 1/2"

26.3076	40 x 18 mm
26.3077	60 x 20 mm
26.3078	60 x 25 mm
26.3079	75 x 30 mm
26.3080	75 x 40 mm



Langenbeck
21,0 cm/8 1/4"

26.3085	30 x 11 mm
26.3086	30 x 14 mm
26.3087	30 x 16 mm
26.3088	40 x 11 mm
26.3089	50 x 11 mm

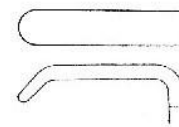

Kocher-Langenbeck
21,5 cm/8 1/2"

26.3090	25 x 6 mm
26.3091	35 x 8 mm
26.3092	35 x 11 mm
26.3093	35 x 15 mm
26.3094	40 x 11 mm
26.3095	55 x 11 mm
26.3096	70 x 14 mm
26.3097	80 x 12 mm
26.3098	80 x 16 mm

Wundhaken
Retractors
Ecarteurs
Separadores



Langenbeck
22,0 cm/8³/₄"



26.3081 30 x 11 mm
26.3082 30 x 14 mm
26.3083 30 x 16 mm



26.3084 40 x 11 mm



Sauerbruch
22,5 cm/9"

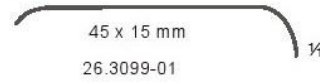

45 x 15 mm
26.3099-01

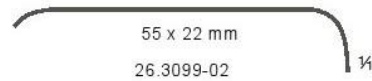

55 x 22 mm
26.3099-02

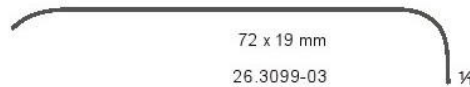

72 x 19 mm
26.3099-03

Wundhaken
Retractors
Ecarteurs
Separadores



Lahey
26.3100
19,0 cm/7½"

Richardson
24,0 cm/9½"

Richardson
26.3104
24,0 cm/9½"

Kelly
26.3105
26,0 cm/10¼"

Wundhaken
Retractors
Ecarteurs
Separadores

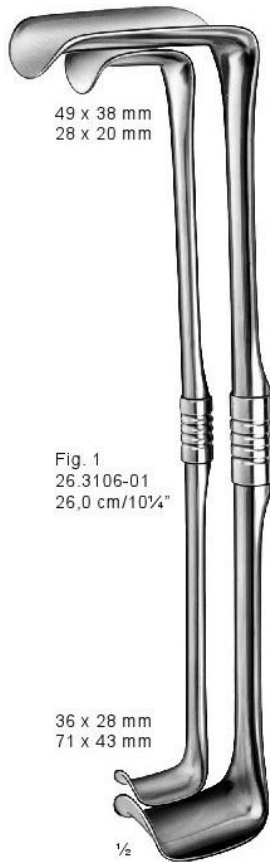

49 x 38 mm
28 x 20 mm

Fig. 1
26.3106-01
26,0 cm/10 $\frac{1}{4}$ "

Fig. 2
26.3106-02
28,0 cm/11"

36 x 28 mm
71 x 43 mm

$\frac{1}{2}$

Richardson-Eastman

26.3106
Satz 2-teilig
Set of 2 pieces
Jeu de 2 pièces
Juego de 2 piezas

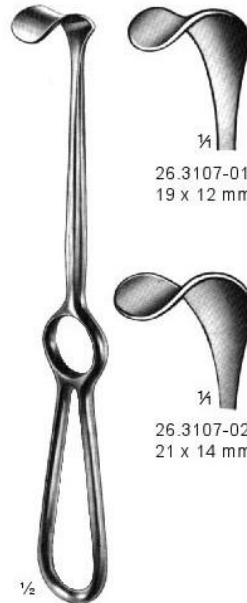

$\frac{1}{4}$

26.3107-01
19 x 12 mm

$\frac{1}{4}$

26.3107-02
21 x 14 mm

$\frac{1}{2}$

Kocher
20,5 cm/8"



$\frac{1}{2}$

Kocher
22,0 cm/8 $\frac{3}{4}$ "

26.3108-01
40 x 10 mm

26.3108-02
40 x 15 mm

26.3108-03
40 x 20 mm

Wundhaken
Retractors
Ecarteurs
Separadores

26



Middeldorpf



1/2
26.3109-01
14 x 17 mm
21,5 cm/8 1/2"



1/2
26.3109-02
20 x 22 mm
22,0 cm/8 3/4"



1/2
26.3109-03
26 x 30 mm
23,5 cm/9 1/2"

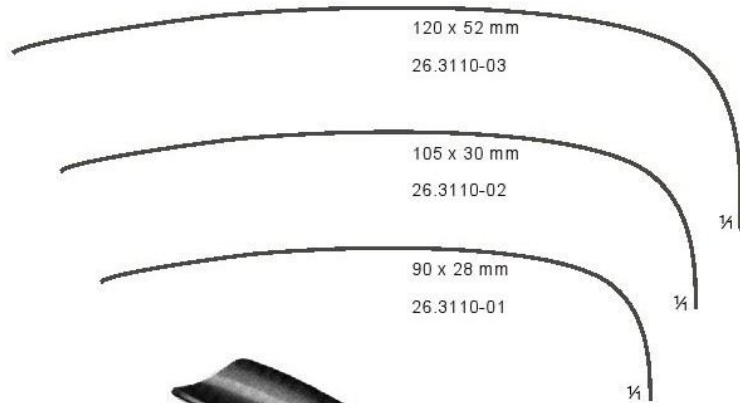

Doyen-Stille
22,0 cm/8 3/4"

Wundhaken
Retractors
Ecarteurs
Separadores

26

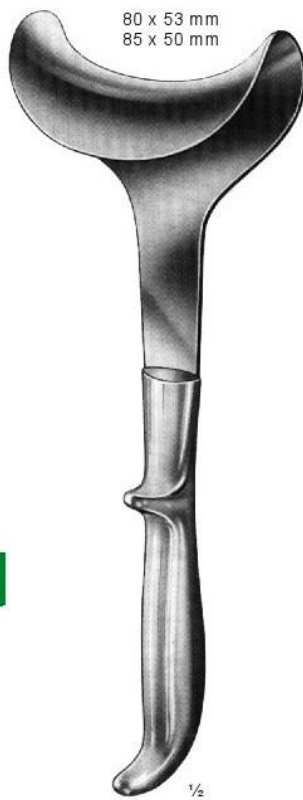

Doyen
25,0 cm/10"

26.3116-80 53 x 80 mm
26.3116-85 50 x 85 mm

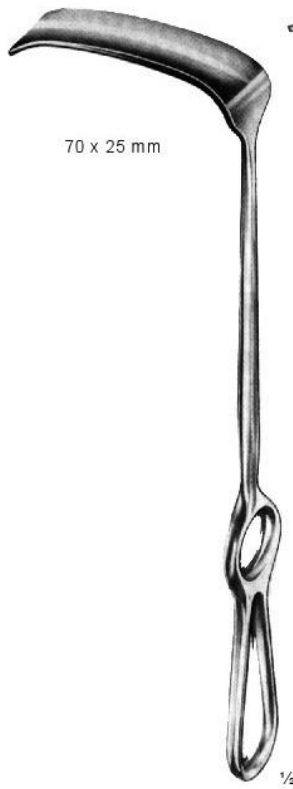

Kocher
23,5 cm/9 1/4"

26.3117-23

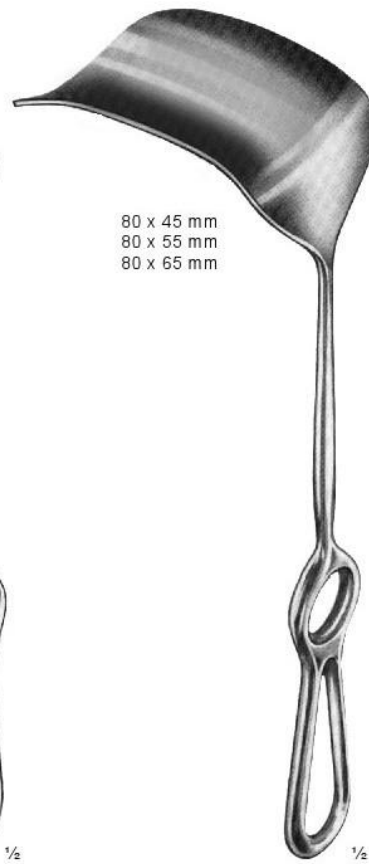

Kocher
25,0 cm/10"

26.3118-01 80 x 45 mm
26.3118-02 80 x 55 mm
26.3118-03 80 x 65 mm

Wundhaken
Retractors
Ecarteurs
Separadores

26

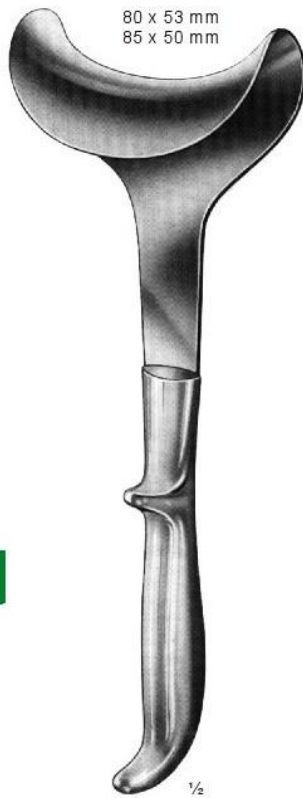

Doyen
25,0 cm/10"

26.3116-80 53 x 80 mm
26.3116-85 50 x 85 mm

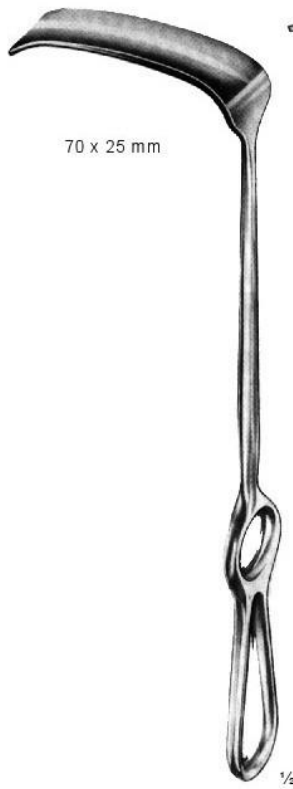

Kocher
23,5 cm/9 1/4"

26.3117-23

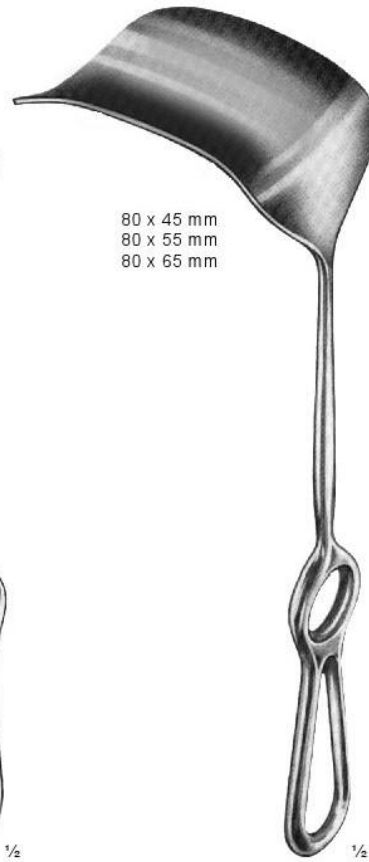

Kocher
25,0 cm/10"

26.3118-01 80 x 45 mm
26.3118-02 80 x 55 mm
26.3118-03 80 x 65 mm

Wundhaken
Retractors
Ecarteurs
Separadores



Hösel
25,0 cm/10"

1/2



60 x 20 mm
26.3119-01

1/4

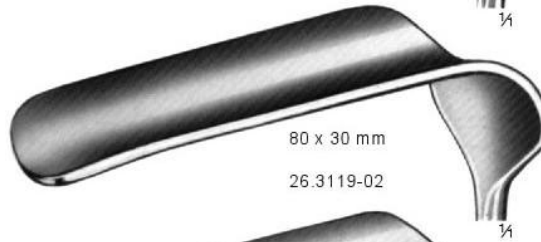

80 x 30 mm
26.3119-02

1/4

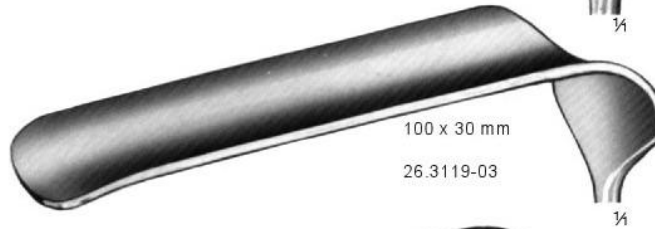

100 x 30 mm
26.3119-03

1/4



120 x 30 mm
26.3119-04

1/4



140 x 30 mm
26.3119-05

1/4



140 x 40 mm
26.3119-06

1/4

26

Wundhaken
Retractors
Ecarteurs
Separadores

26



1/2

Zenker

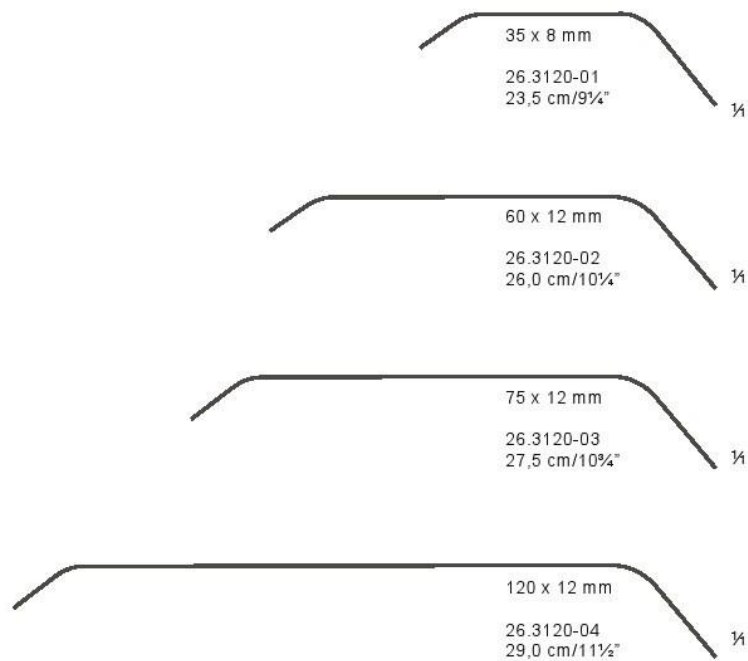

Wundhaken
Retractors
Ecarteurs
Separadores

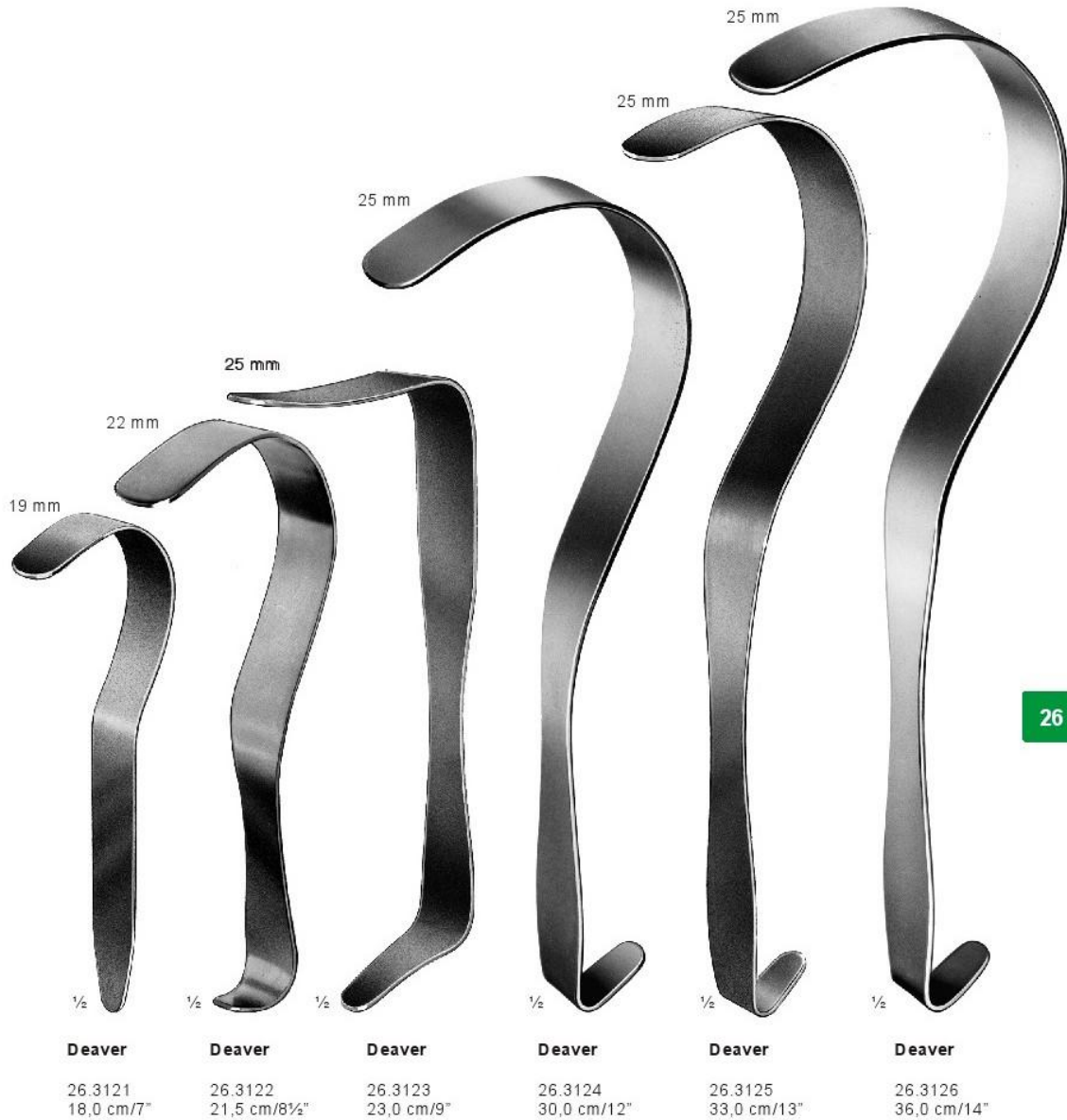

26

Wundhaken
Retractors
Ecarteurs
Separadores



26

Deaver

26.3127
30,0 cm/12"

Deaver

26.3128
30,0 cm/12"

Deaver

26.3129
30,0 cm/12"

Harrington

32,0 cm/12½"

26.3132 127 x 40 mm
26.3133 127 x 62 mm

Wundhaken
Retractors
Ecarteurs
Separadores

115 x 22 mm
115 x 26 mm



Simon
27,5 cm/10¾"

26.3135-01 115 x 22 mm
26.3135-02 115 x 26 mm

95 x 20 mm



Modell Tübingen

26.3136-26
26,5 cm/10½"

105 x 27 mm



Martin

26.3137-25
25,0 cm/10"

26

Wundhaken
Retractors
Ecarteurs
Separadores

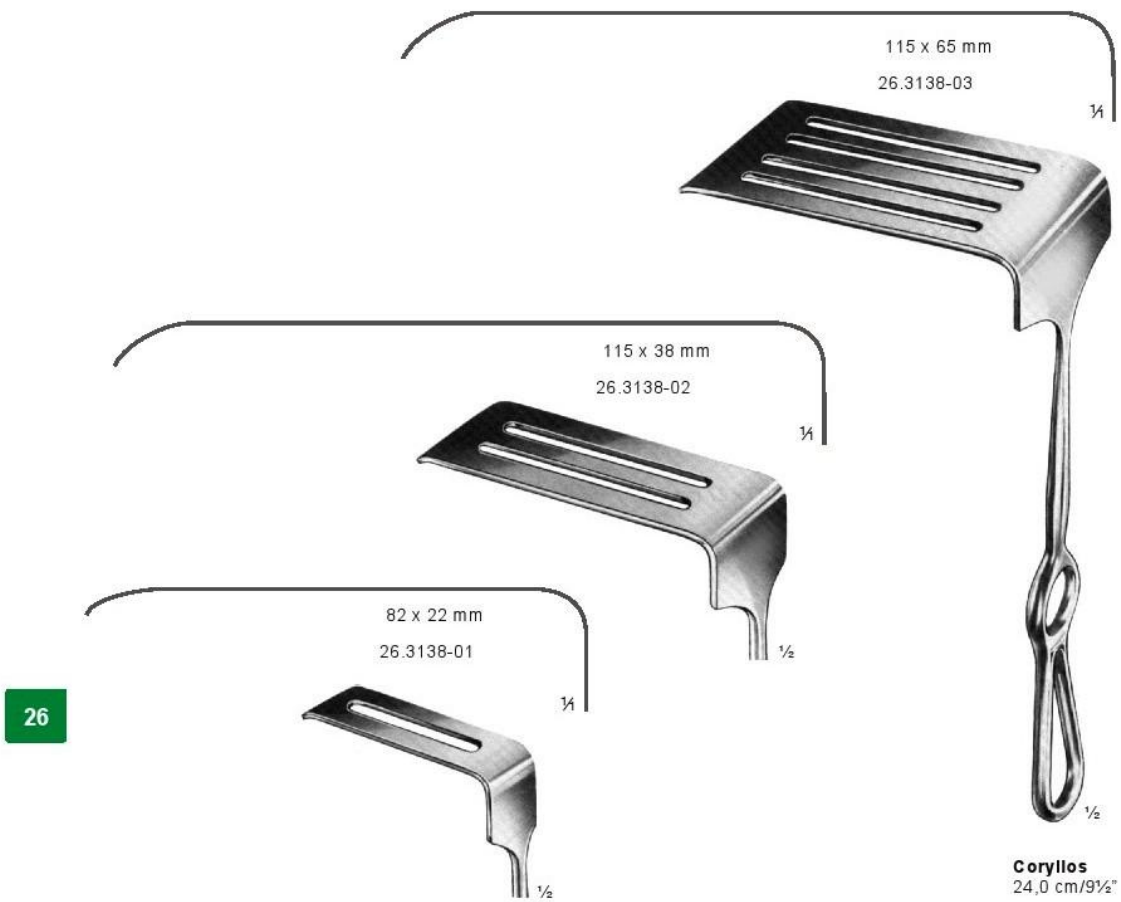

Wundhaken
Retractors
Ecarteurs
Separadores

26.3139-01
75 x 50 mm

26.3139-02
75 x 90 mm

Davidson
16,0 cm/6¼"



125 x 37 mm

¼

Sauerbruch

26.3140-25
25,0 cm/10"

⅓

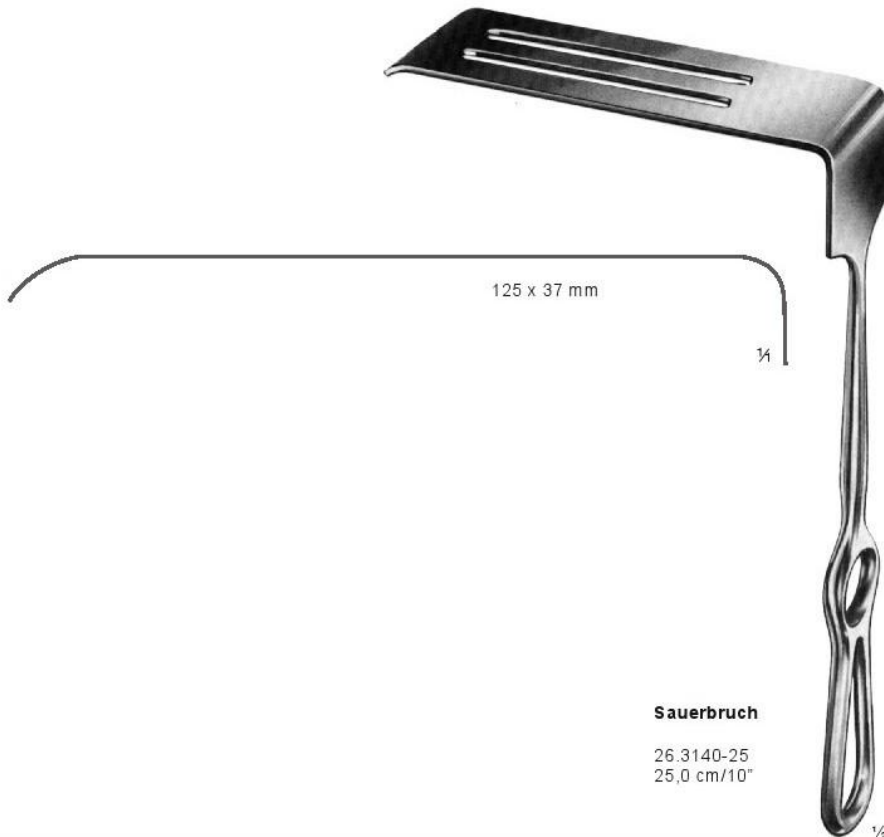

Wundhaken
Retractors
Ecarteurs
Separadores

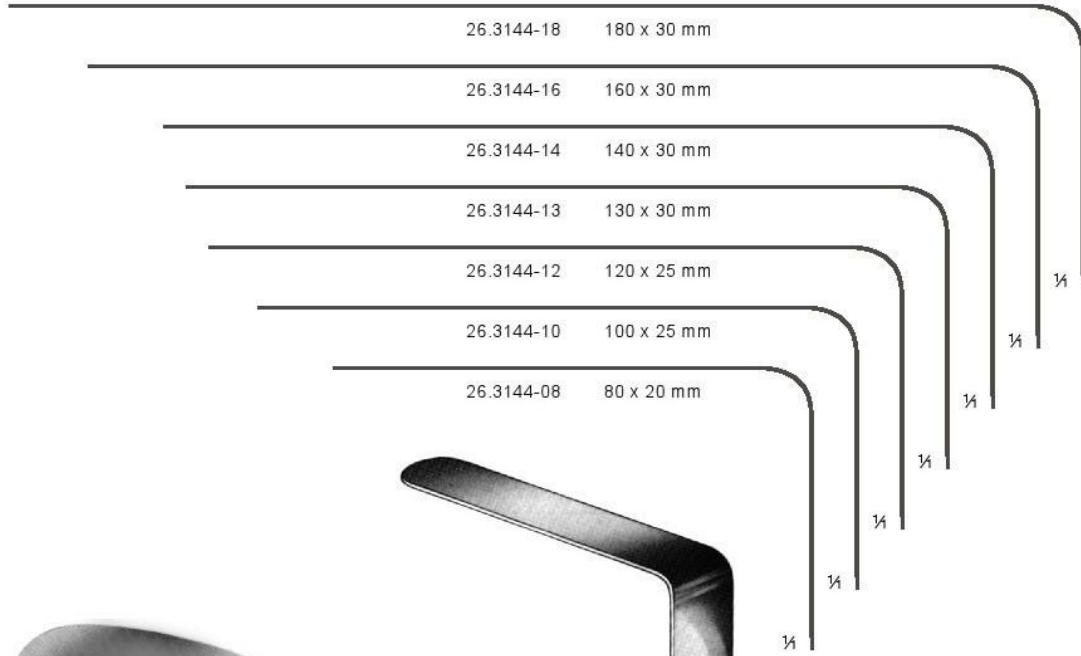

26



Mikulicz
26,0 cm/10¼"
26.3141 85 x 35 mm
26.3142 120 x 50 mm
26.3143 155 x 50 mm



Brunner
25,0 cm/10"

Wundhaken
Retractors
Ecarteurs
Separadores

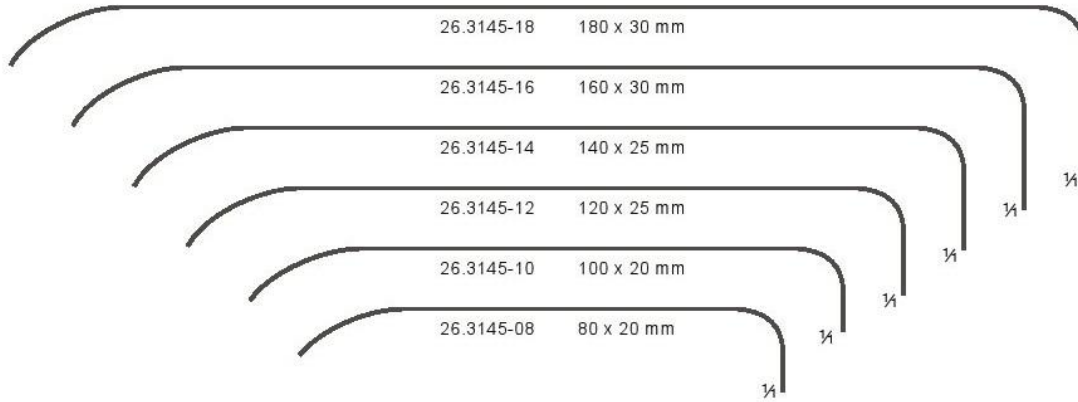

Brunner
25,0 cm/10"

Wundhaken
Retractors
Ecarteurs
Separadores

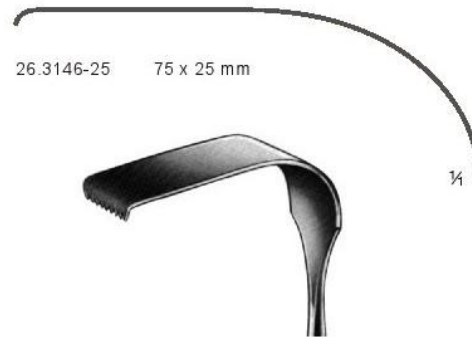
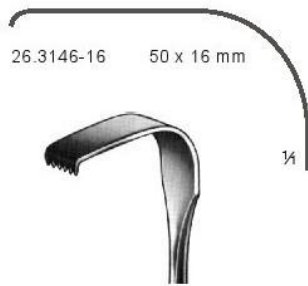

26

Wundhaken
Retractors
Ecarteurs
Separadores

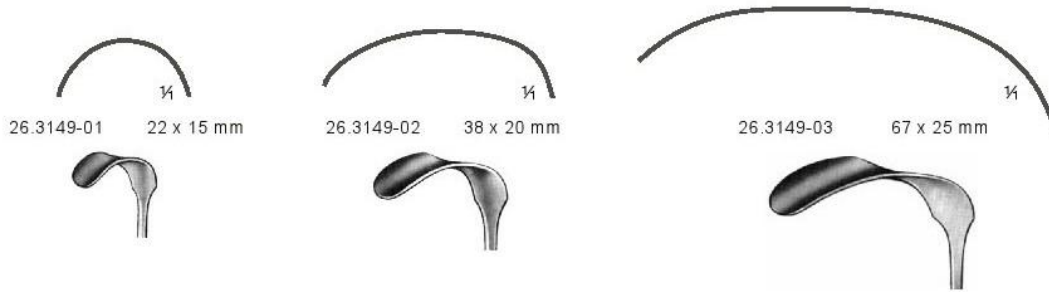

26

Wundhaken
Retractors
Ecarteurs
Separadores

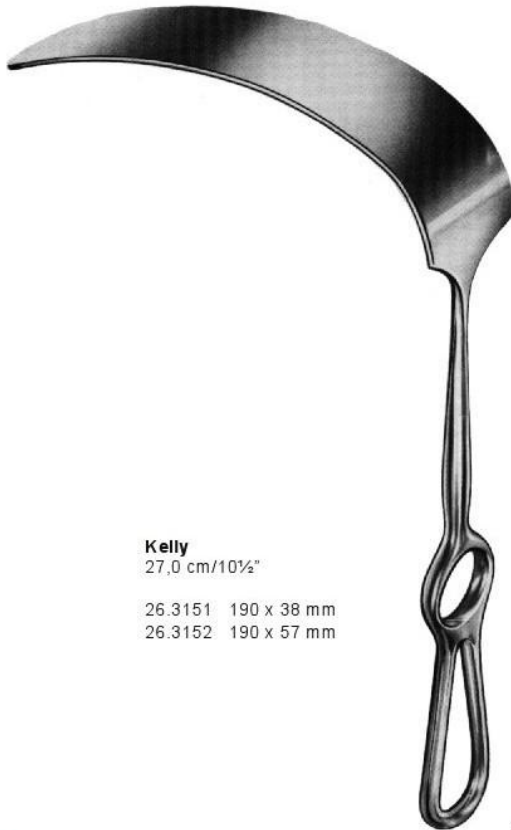

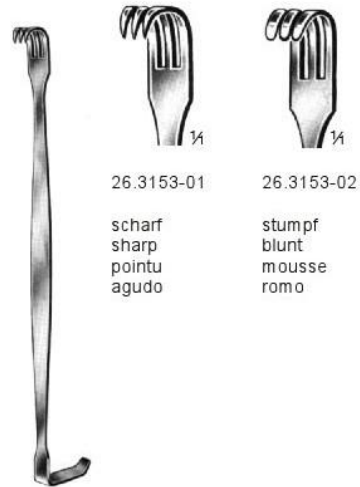

Kelly
27,0 cm/10½"

26.3151 190 x 38 mm
26.3152 190 x 57 mm



Baby-Senn-Miller
15,5 cm/6"

	
26.3153-01	26.3153-02
scharf sharp pointu agudo	stumpf blunt mousse romo

26

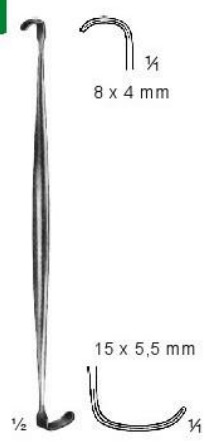

Ragnell-Davis



26.3154
14,0 cm/5½"

8 x 4 mm

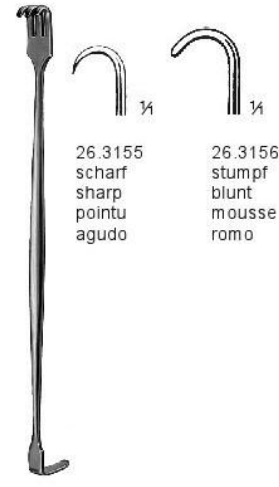
15 x 5,5 mm



Senn-Miller
16,0 cm/6¼"

	
26.3155	26.3156
scharf sharp pointu agudo	stumpf blunt mousse romo



Senn-Green
15,0 cm/6"

26.3157
20 x 6 mm

26.3158
10 x 6 mm

Wundhaken
Retractors
Ecarteurs
Separadores

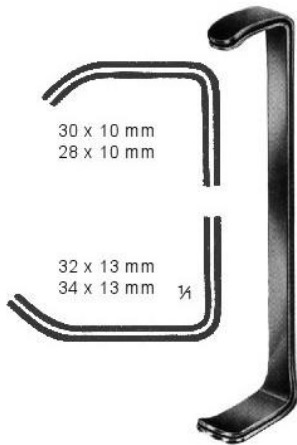

Farabeuf
12,0 cm/4 1/4"

26.3160
Satz, set
jeu, juego

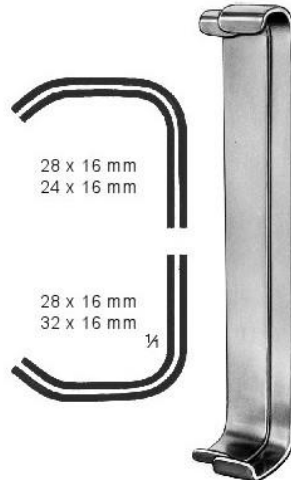

Farabeuf
15,0 cm/6"

26.3161
Satz, set
jeu, juego

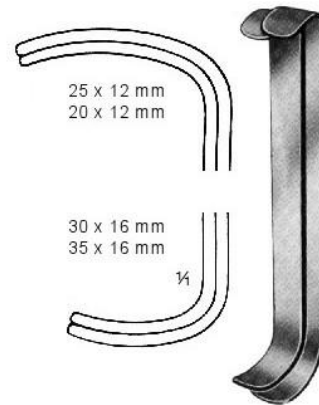

Collin
15,0 cm/6"

26.3162
Satz, set
jeu, juego



Mathieu
20,0 cm/8"

26.3164
Satz, set
jeu, juego

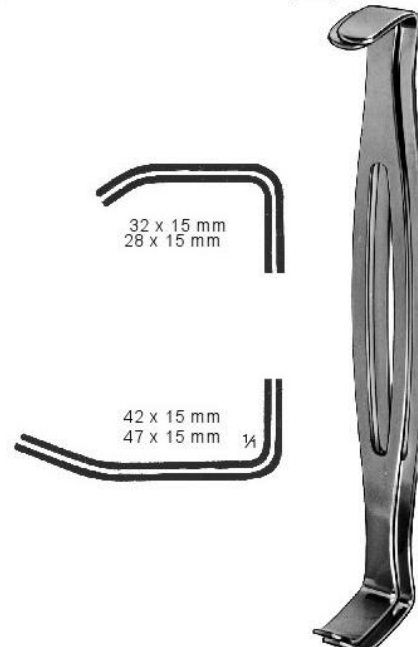

Parker-Langenbeck
(US-Army)
21,0 cm/8 1/4"

26.3165
Satz, set
jeu, juego

Wundhaken
Retractors
Ecarteurs
Separadores

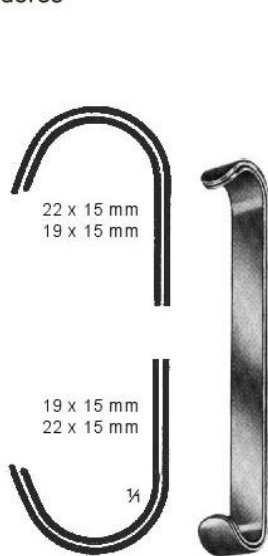

Parker
13,5 cm/5¼"

26.3166
Satz, set
jeu, juego

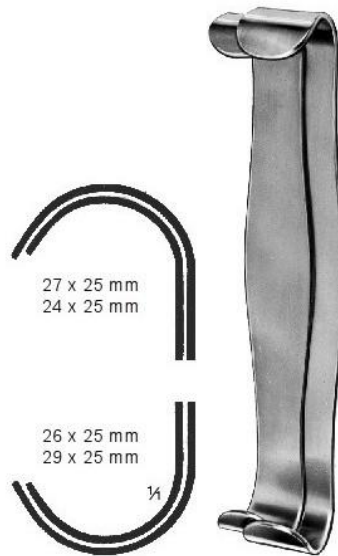

Parker
18,0 cm/7"

26.3167
Satz, set
jeu, juego

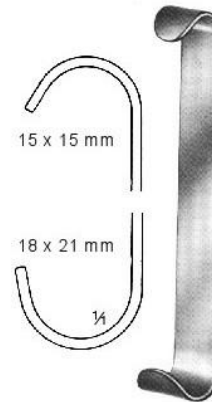

Baby-Roux
13,0 cm/5¼"

26.3168

26



Mini-Roux
15,0 cm/6"

26.3169

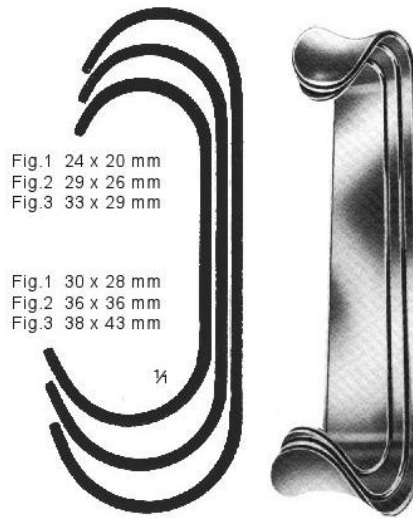

Roux

26.3170-00
Satz, set
jeu, juego

Roux

Fig.1 26.3171 14,0 cm/5½"
Fig.2 26.3172 15,0 cm/6"
Fig.3 26.3173 17,0 cm/6¾"

Wundhaken
Retractors
Ecarteurs
Separadores



26.3176-01
scharf
sharp
pointu
agudo

Finsen
5,0 cm/2"

26.3176-02
stumpf
blunt
mousse
romo



26.3177-01
scharf
sharp
pointu
agudo

Finsen
7,0 cm/2¾"

26.3177-02
stumpf
blunt
mousse
romo



26.3178-01
scharf
sharp
pointu
agudo

Jansen
10,0 cm/4"



26.3178-02
stumpf
blunt
mousse
romo

Jansen
10,0 cm/4"



26.3179-01
scharf
sharp
pointu
agudo

Holtzheimer
10,0 cm/4"

26.3179-02
stumpf
blunt
mousse
romo

Wundhaken
Retractors
Ecarteurs
Separadores



Weitlaner-Loktite
10,5 cm/4 1/4"

26.3181
scharf
sharp
pointu
agudo

26.3191
stumpf
blunt
mousse
romo



Weitlaner-Loktite

26.3183
26.3186
26.3189
scharf
sharp
pointu
agudo

13,0 cm/5"
16,5 cm/6 1/2"
20,0 cm/8"

26.3193
26.3196
26.3199
stumpf
blunt
mousse
romo

26



Weitlaner-Wullstein
13,0 cm/5"

26.3202-01
scharf
sharp
pointu
agudo

26.3202-02
stumpf
blunt
mousse
romo

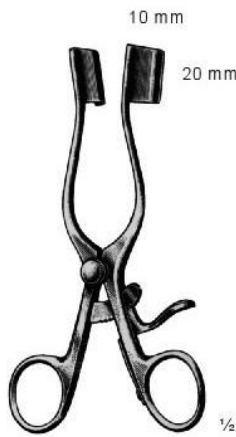

Weitlaner-Baby
13,0 cm/5"

26.3203



Scalp Contour
14,0 cm/5 1/2"

26.3204-01
scharf
sharp
pointu
agudo

26.3204-02
stumpf
blunt
mousse
romo

Wundhaken
Retractors
Ecarteurs
Separadores

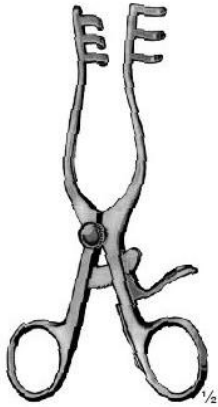

HB 3205
stumpf
blunt
mousse
romo

Milligan
13,0 cm/5"



26.3206-01
scharf
sharp
pointu
agudo

Plester
13,0 cm/5"

26.3206-02
stumpf
blunt
mousse
romo



26.3207
stumpf
blunt
mousse
romo

Plester
11,0 cm/4¼"



26.3208
stumpf
blunt
mousse
romo

Plester
11,0 cm/4¼"

Wundhaken
Retractors
Ecarteurs
Separadores



Cone

26.3210-01	13,0 cm/5"	26.3210-02
26.3211-01	16,5 cm/6½"	26.3211-02
26.3212-01	20,0 cm/8"	26.3212-02
26.3213-01	25,0 cm/9½"	26.3213-02
scharf		stumpf
sharp		blunt
pointu		mousse
agudo		romo



Tübinger Modell

26.3216
16,5 cm/6½"

26



Mollison
15,5 cm/6"

26.3217
scharf
sharp
pointu
agudo



Adson-Baby
16,0 cm/6¼"

26.3218
scharf
sharp
pointu
agudo

26.3219
stumpf
blunt
mousse
romo

Wundhaken
Retractors
Ecarteurs
Separadores

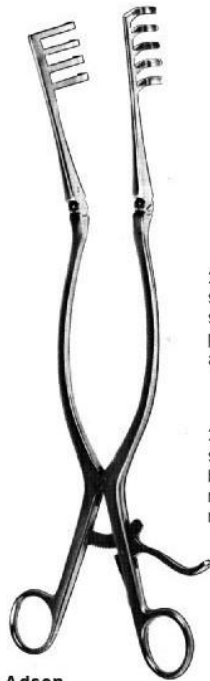

26.3220-01
scharf
sharp
pointu
agudo

Adson
32,0 cm/12½"

26.3220-02
stumpf
blunt
mousse
romo



26.3221-01
scharf
sharp
pointu
agudo

Beckmann
31,0 cm/12¼"

26.3221-02
stumpf
blunt
mousse
romo



26.3222-01
scharf
sharp
pointu
agudo

Adson
20,0 cm/8"

26.3222-02
stumpf
blunt
mousse
romo

Wundhaken
 Retractors
 Ecarteurs
 Separadores

26

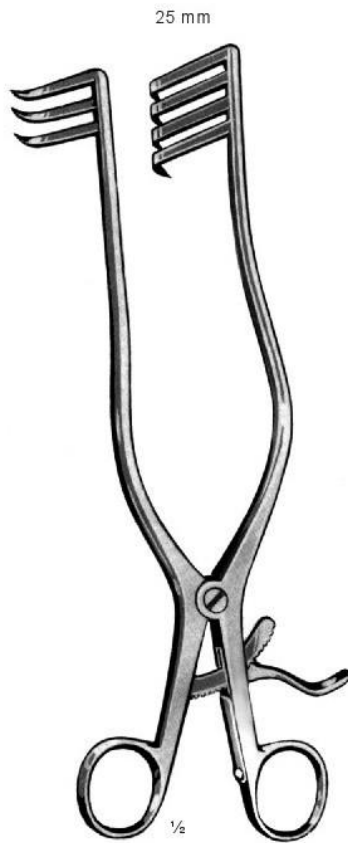

Adson
 26,5 cm/10½"

- | | |
|------------|------------|
| 26.3223-01 | 26.3223-02 |
| scharf | stumpf |
| sharp | blunt |
| pointu | mousse |
| agudo | romo |



Adson
 26,5 cm/10½"

- | | |
|------------|------------|
| 26.3224-01 | 26.3224-02 |
| scharf | stumpf |
| sharp | blunt |
| pointu | mousse |
| agudo | romo |

Wundhaken
Retractors
Ecarteurs
Separadores



Beckmann-Eaton
32,0 cm/12 $\frac{3}{4}$ "

26.3225
scharf
sharp
pointu
agudo



Beckmann-Adson
31,0 cm/12 $\frac{1}{4}$ "



26.3226-00
stumpf
blunt
mousse
romo

26.3226-01
scharf
sharp
pointu
agudo

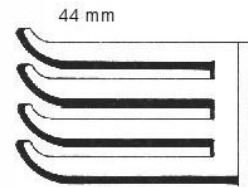

26.3226-02
stumpf
blunt
mousse
romo

26.3226-03
scharf
sharp
pointu
agudo



Anderson-Adson
19,5 cm/8"

26.3228
scharf
sharp
pointu
agudo

gewinkelte Arme
angular
angie
angulado

Wundspreizer
Abdominal Retractors
Ecarteurs abdominaux
Separadores abdominales

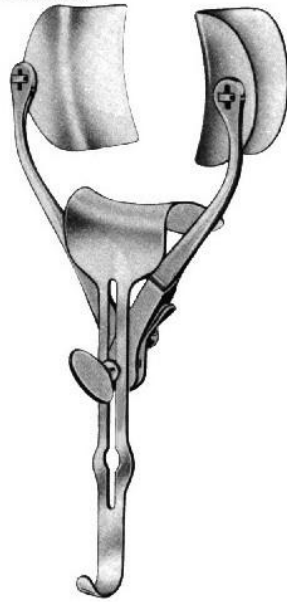

Ricard
 26.3305-28 280 mm 72 x 85 mm 80 x 90 mm
 26.3305-30 300 mm 60 x 80 mm 55 x 70 mm
 Spreizweite Seitliche Valven Mittelvalve
 Spread Lateral blades Center blade
 Ecartement Valves latérales Valve centrale
 Apertura de la hoja Valvas laterales Valva central



Holzbach
 26.3307 62 x 80 mm 80 x 80 mm
 Seitliche Valven Mittelvalve
 Lateral blades Center blade
 Valves latérales Valve centrale
 Valvas laterales Valva central

26



Collin-Loktite
 26,0 cm/10½"
 26.3308 160 mm 60 x 80 mm 60 x 75 mm
 Spreizweite Seitliche Valven Mittelvalve
 Spread Lateral blades Center blade
 Ecartement Valves latérales Valve centrale
 Apertura de la hoja Valvas laterales Valva central

**Wundspreizer
Abdominal Retractors
Ecarteurs abdominaux
Separadores abdominales**



Baby-Collin

26.3309	80 mm	27 x 40 mm
	Spreizweite	18 x 40 mm
	Spread	Seitliche Valven
	Ecartement	Lateral blades
	Apertura de la hoja	Valvas laterales
		Valvas laterales

komplett mit 2 Paar Valven
complete, with 2 pairs of blades
complet, avec 2 paires de valves
completo, con 2 pares de valvas



Collin

26.3310	100 mm	38 x 60 mm
	Spreizweite	Seitliche Valven
	Spread	Lateral blades
	Ecartement	Valves laterales
	Apertura de la hoja	Valvas laterales



Collin-Loktite

26.3311	100 mm	38 x 60 mm	38 x 55 mm
26.3312	100 mm	38 x 80 mm	50 x 75 mm
	Spreizweite	Seitliche Valven	Mittelvalve
	Spread	Lateral blades	Center blade
	Ecartement	Valves laterales	Valve centrale
	Apertura de la hoja	Valvas laterales	Valva central



**Wechselvalven
Exchangeable blades
Valves interchangeables
Valvas intercambiables**

26.3313-18	18 x 40 mm
26.3313-27	27 x 40 mm
26.3313-38	38 x 60 mm
26.3313-40	40 x 80 mm
26.3313-45	45 x 80 mm
26.3313-60	60 x 80 mm

Wundspreizer
Abdominal Retractors
Ecarteurs abdominaux
Separadores abdominales



Gosset
 26.3315 100 mm 30 x 40 mm
 Spreizweite Seitliche Valven
 Spread Lateral blades
 Ecartement Valves latérales
 Apertura de la hoja Valvas latérales



Gosset
 26.3316 100 mm 30 x 40 mm
 Spreizweite Seitliche Valven
 Spread Lateral blades
 Ecartement Valves latérales
 Apertura de la hoja Valvas latérales

26



Gosset
 26.3317 140 mm 35 x 63 mm
 Spreizweite Seitliche Valven
 Spread Lateral blades
 Ecartement Valves latérales
 Apertura de la hoja Valvas latérales



Gosset
 26.3318 160 mm 35 x 63 mm 56 x 60 mm
 Spreizweite Seitliche Valven Mittelvalve
 Spread Lateral blades Center blade
 Ecartement Valves latérales Valve centrale
 Apertura de la hoja Valvas latérales Valva central

**Wundspreizer
Abdominal Retractors
Ecarteurs abdominaux
Separadores abdominales**



Balfour-Baby
26.3320

90 mm	26 x 38 mm	25 x 23 mm
Spreizweite	Seitliche Valven	Mittelvalve
Spread	Lateral blades	Center blade
Ecartement	Valves latérales	Valve centrale
Apertura de la hoja	Valvas laterales	Valva central



Balfour
26.3321

180 mm	35 x 70 mm	45 x 80 mm
Spreizweite	Seitliche Valven	Mittelvalve
Spread	Lateral blades	Center blade
Ecartement	Valves latérales	Valve centrale
Apertura de la hoja	Valvas laterales	Valva central

26



Balfour
26.3323

200 mm	35 x 100 mm	60 x 100 mm
Spreizweite	Seitliche Valven	Mittelvalve
Spread	Lateral blades	Center blade
Ecartement	Valves latérales	Valve centrale
Apertura de la hoja	Valvas laterales	Valva central

Wundspreizer
Abdominal Retractors
Ecarteurs abdominaux
Separadores abdominales

26

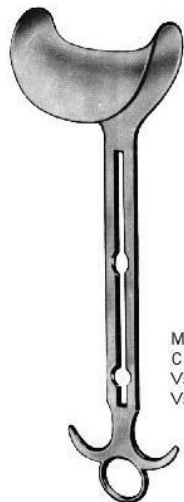

Mittelvalve allein
 Center blade only
 Valve centrale seule
 Valva central suelta

Balfour	
26.3326-01	45 x 80 mm
26.3326-02	70 x 85 mm
26.3326-03	100 x 60 mm



Balfour
26.3325

180 mm	35 x 70 mm	45 x 80 mm
Spreizweite	Seitliche Valven	Mittelvalve
Spread	Lateral blades	Center blade
Ecartement	Valves latérales	Valve centrale
Apertura de la hoja	Valvas latérales	Valva central

**Wundspreizer
Abdominal Retractors
Ecarteurs abdominaux
Separadores abdominales**

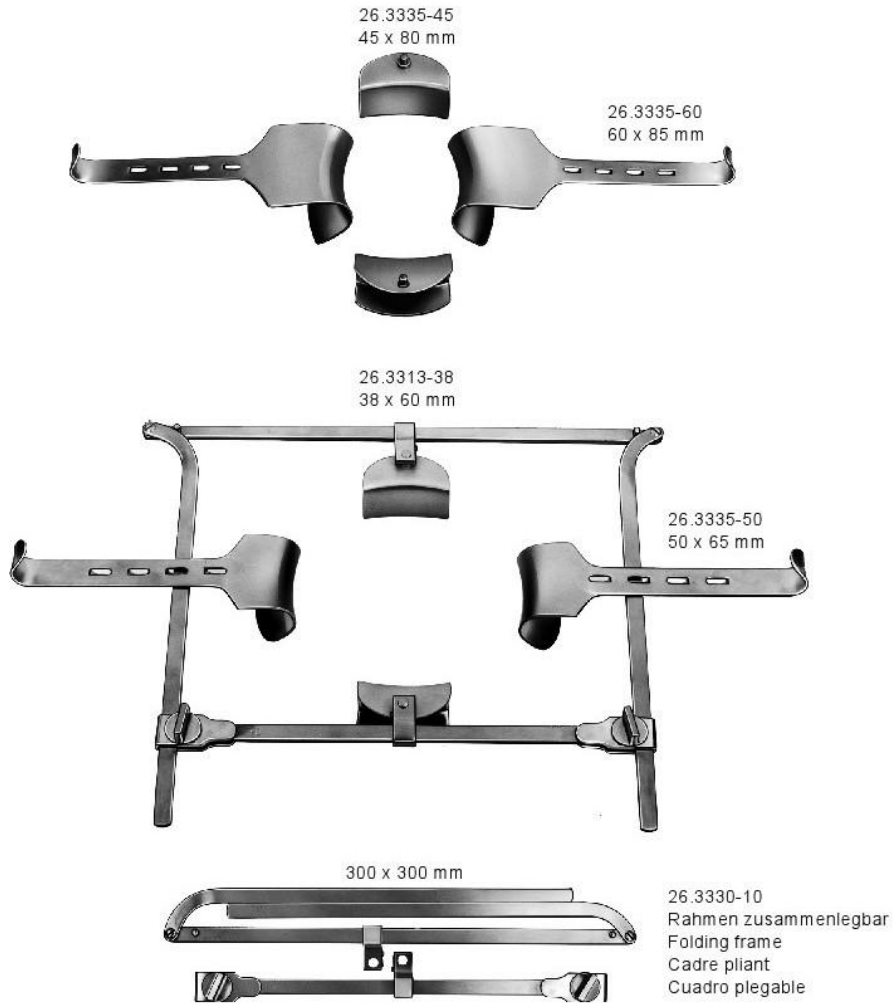

26

Franz			Tiefe		Breite	
			Depth	Profondeur	Width	Largueur
			Profundidad	Anchura		
26.3330-00	mit 4 Valven with 4 valves avec 4 valves con 4 valvas	2x	50	x	65	mm
		2x	38	x	60	mm
26.3331-00	mit 8 Valven with 8 valves avec 8 valves con 8 valvas	2x	50	x	65	mm
		2x	38	x	60	mm
		2x	60		85	
		2x	45		80	

Wundspreizer
Abdominal Retractors
Ecarteurs abdominaux
Separadores abdominales

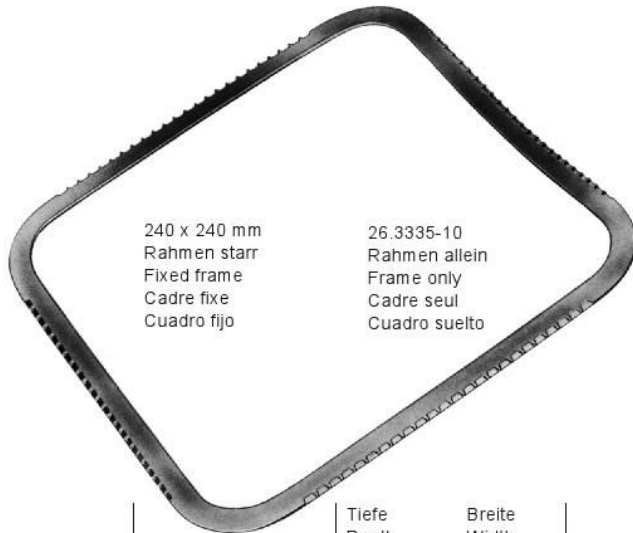

240 x 240 mm
 Rahmen starr
 Fixed frame
 Cadre fixe
 Cuadro fijo

26.3335-10
 Rahmen allein
 Frame only
 Cadre seul
 Cuadro suelto



Kirschner
 26.3335-40 40 x 55 mm
 26.3335-50 50 x 65 mm
 26.3335-60 60 x 85 mm
 26.3335-78 78 x 65 mm
 26.3335-80 80 x 90 mm



Kirschner
 26.3335-98 98 x 50 mm
 26.3335-99 105 x 35 mm

Kirschner			Tiefe Depth Profondeur Profundidad	x	Breite Width Largueur Anchura	
26.3335-00	mit 4 Valven with 4 valves avec 4 valves con 4 valvas	2x 2x	40 50	x x	55 65	mm mm

26

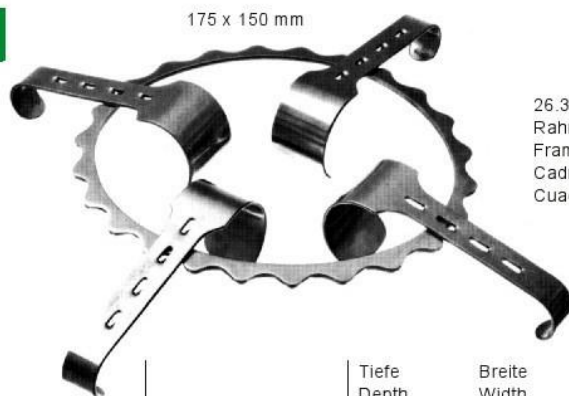

175 x 150 mm

26.3336-10
 Rahmen allein
 Frame only
 Cadre seul
 Cuadro suelto

Valven allein
 Valves only
 Valves seules
 Valvas sueltas

Denis-Browne			Tiefe Depth Profondeur Profundidad	x	Breite Width Largueur Anchura	
26.3336-00	mit 4 Valven with 4 valves avec 4 valves con 4 valvas	2x 2x	40 40	x x	30 40	mm mm

Denis-Browne
 26.3336-01 20 x 30 mm
 26.3336-02 20 x 40 mm
 26.3336-03 40 x 30 mm
 26.3336-04 40 x 40 mm

Wundspreizer
Abdominal Retractors
Ecarteurs abdominaux
Separadores abdominales



26.3340-10
 Rahmen allein
 Frame only
 Cadre seul
 Cuadro suelto



O'Sullivan-O'Connor

26.3340-00

mit 3 Valven
 with 3 valves
 avec 3 valves
 con 3 valvas

2x
 1x

Tiefe Depth Profondeur Profundidad	Breite Width Largueur Anchura
80 x 110 x	45 mm 70 mm

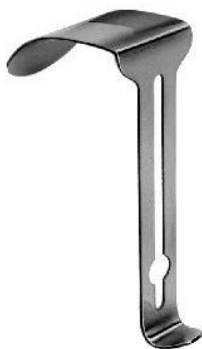

Valve allein
 Valve only
 Valve seule
 Valva suelta

26.3340-45
 80 x 45 mm



Valve allein
 Valve only
 Valave seule
 Valva suelta

26.3340-70
 110 x 70 mm

Wundspreizer
Abdominal Retractors
Ecarteurs abdominaux
Separadores abdominales



Rigby
 26.3342 100 mm 70 x 16 mm
 Spreizweite Seitliche Valven
 Spread Lateral blades
 Ecartement Valves latérales
 Apertura de la hoja Valvas latérales

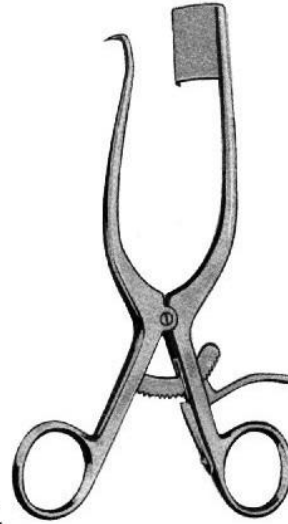

Markham-Meyerdig
 26.3343-01 83 mm 45 x 25 mm
 Spreizweite Valve rechts
 Spread Blade right side
 Ecartement Valve à droite
 Apertura de la hoja Valva a la derecha

26



Markham-Meyerdig
 26.3343-02 83 mm 45 x 25 mm
 Spreizweite Valve links
 Spread Blade left side
 Ecartement Valve à gauche
 Apertura de la hoja Valva a la izquierda



Meyerdig
 26.3344-01 25 x 30 mm
 26.3344-02 25 x 55 mm
 26.3344-03 25 x 60 mm
 26.3344-04 20 x 60 mm
 Seitliche Valven
 Lateral blades
 Valves latérales
 Valvas latérales

**Wundspreizer
Abdominal Retractors
Ecarteurs abdominaux
Separadores abdominales**



Gelpi-Loktite

26.3345-09 9,0 cm/3½"
26.3345-11 11,5 cm/4½"



Gelpi-Loktite

26.3345-14 14,0 cm/5½"
26.3345-18 18,0 cm/7"

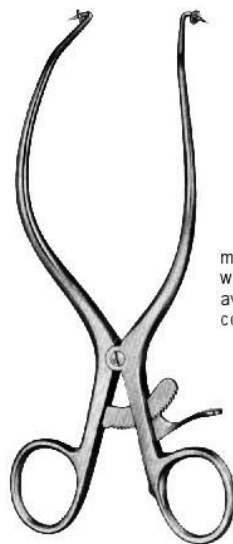

Gelpi-Loktite

26.3346-18 18,0 cm/7"

mit Kugel
with balls
avec boules
con bolas



DeBaKey

26.3348 100 mm
26.3349 145 mm
Spreizweite
Spread
Ecartement
Apertura de la hoja

Wundspreizer
Abdominal Retractors
Ecarteurs abdominaux
Separadores abdominales

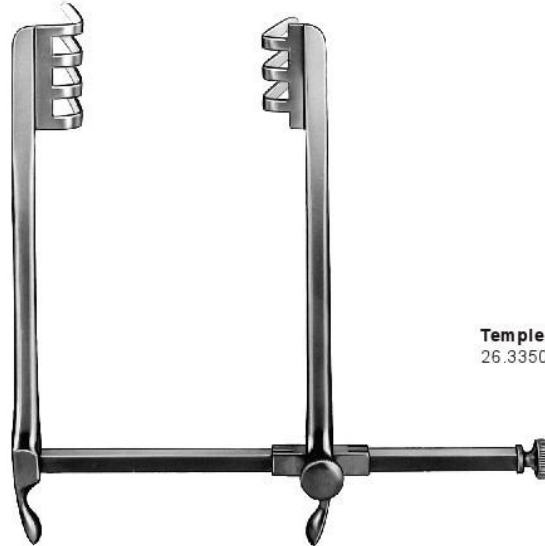

Temple-Fay
26.3350 120 mm
Spreizweite
Spread
Ecartement
Apertura de la hoja

26

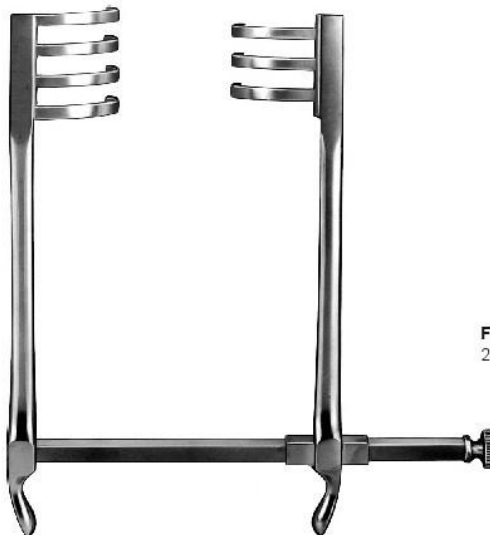

Frazier
26.3351 85 mm
Spreizweite
Spread
Ecartement
Apertura de la hoja

**Wundspreizer
Abdominal Retractors
Ecarteurs abdominaux
Separadores abdominales**

biegsam, flexible, malléable, flexible



26.3360	26.3361	26.3362
33,0 cm/13"	33,0 cm/13"	33,0 cm/13"
30 mm	40 mm	50 mm

biegsam, flexible, malléable, flexible



Haberer	26.3365	26.3366
	28,0 cm/11"	30,0 cm/12"
	25 x 30 mm	37 x 45 mm



Reverdin	26.3367
	28,5 cm/11¼"
	65 x 45 mm

26

biegsam, flexible, malléable, flexible



26.3368-06	20,0 cm/8"	6 mm	26.3368-17	20,0 cm/8"	17 mm
26.3368-09	20,0 cm/8"	9 mm	26.3368-20	20,0 cm/8"	20 mm
26.3368-12	20,0 cm/8"	12 mm	26.3368-25	20,0 cm/8"	25 mm

biegsam, flexible, malléable, flexible



Tuffier	26.3369
	20,0 cm/8"
	17 x 25 mm

Wundspreizer
Abdominal Retractors
Ecarteurs abdominaux
Separadores abdominales

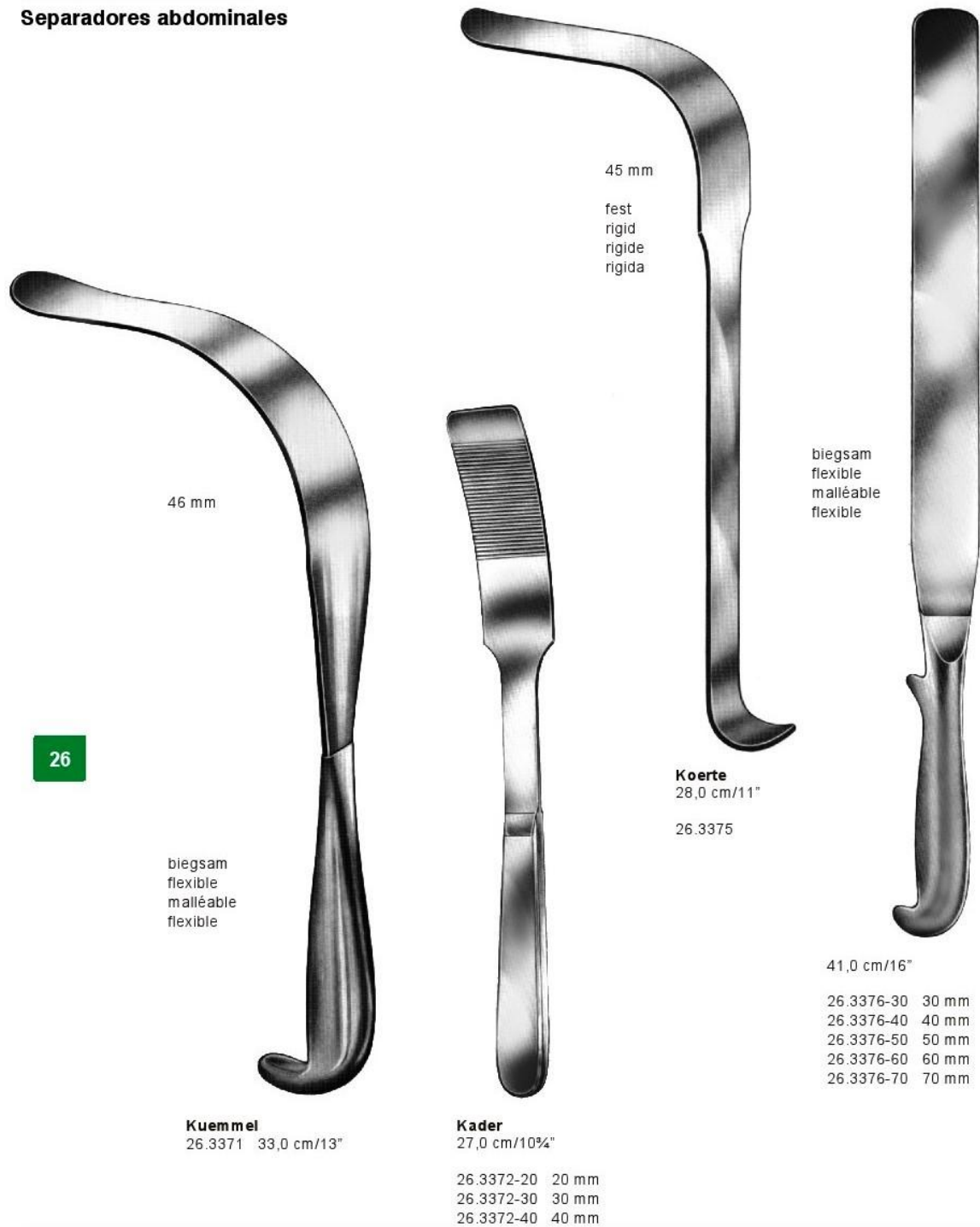

26

46 mm

biegsam
flexible
malléable
flexible

Kuemmel
26.3371 33,0 cm/13"

45 mm
fest
rigid
rigide
rigida



Kader
27,0 cm/10 3/4"

26.3372-20 20 mm
26.3372-30 30 mm
26.3372-40 40 mm

Koerte
28,0 cm/11"
26.3375

biegsam
flexible
malléable
flexible



41,0 cm/16"

26.3376-30 30 mm
26.3376-40 40 mm
26.3376-50 50 mm
26.3376-60 60 mm
26.3376-70 70 mm